

BARE FIBER ADAPTORS

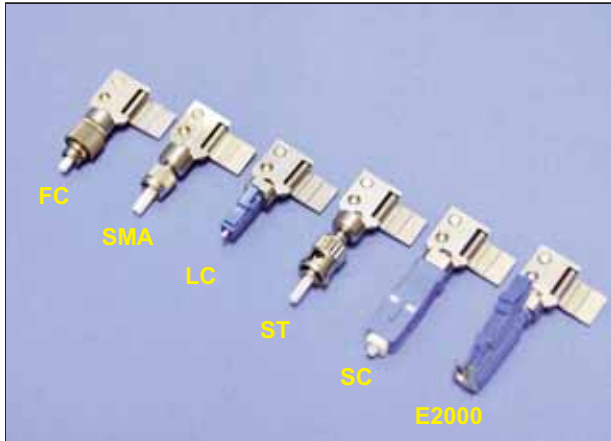

Bare Fiber Adaptors with Magnetic Clamp (PM compatible)



Bare Fiber Adaptors with Spring Clamp

Features:

- Easy to use
- Low cost
- Reusable and easy to clean
- Magnetic clamp applies no stress to the fiber
- Compatible with PM fiber (magnetic clamp version only)
- Variety of connector types (FC, SMA, LC, ST, SC, E2000)
- Variety of fiber sizes available
- 900 micron tight buffer versions available (please ask factory)

Applications:

- Briefly connect to Light Sources, Power Meters, OTDRs, Extinction Ratio Meters, and a variety of other equipment for testing and measurement
- Test unterminated fiber and fiber spools
- Installation and repair work

Description:

Bare fiber adaptors provide a simple and effective way to use unterminated fibers with commercial receptacles. Simply strip, clean and cleave your fiber and insert into the bare fiber adaptor. They are recommended for power meter connections, temporary system repairs or wherever a quick fiber connection is required.

OZ Optics has recently improved the bare fiber adaptor design to now use a magnetic clamping mechanism. The new design gently yet firmly holds the fiber in place without harming soft acrylate coatings, and is even easier for operators to use. The magnetic clamp applies no stress to the fiber, which makes it ideal for PM fiber related measurements including extinction ratio (ER), polarization dependent loss (PDL) and polarization mode dispersion (PMD).

Bare fiber adaptors with the spring clamp accommodate up to 900 micron OD jacketed fiber. Bare fiber adaptors with the magnetic clamp accommodate 250 micron to 400 micron OD jacketed fiber. 900 micron OD tight buffer and custom jacket sizes are available. (Please ask factory).



FC Bare Fiber Adaptor with Magnetic Clamp

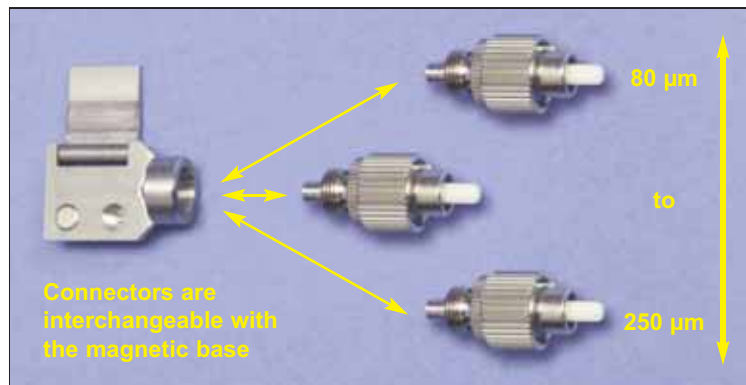

Interchangeable from 80 µm to 250 µm

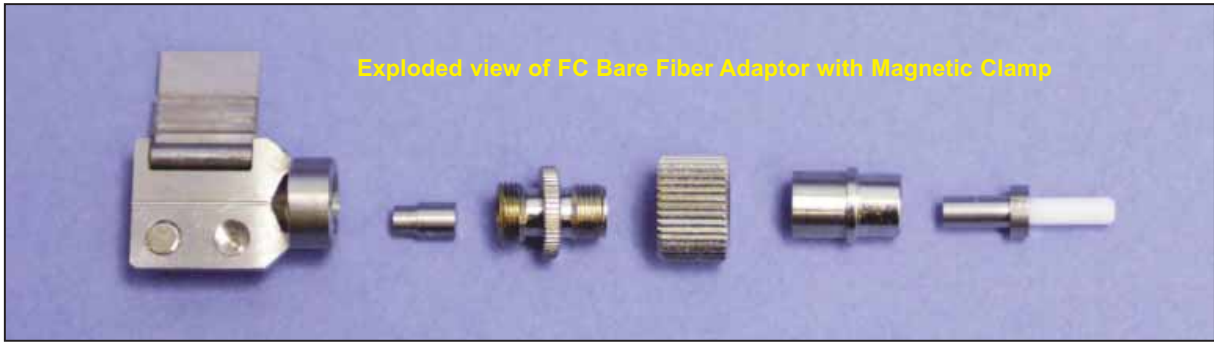

SC Bare Fiber Adaptor with Magnetic Clamp



ST Bare Fiber Adaptor with Magnetic Clamp



SMA Bare Fiber Adaptor with Magnetic Clamp



LC Bare Fiber Adaptor with Magnetic Clamp



E-2000 Bare Fiber Adaptor with Magnetic Clamp

Bar Code	Part Number	Description
44190	BARE-03-127-M	Bare Fiber Adaptor with FC connector, for 125 micron diameter fibers, magnetic clamp
47508	BARE-05-127-M	Bare Fiber Adaptor with SMA 905 connector, for 125 micron diameter fibers, magnetic clamp
47507	BARE-08-127-M	Bare Fiber Adaptor with ST connector, for 125 micron diameter fibers, magnetic clamp
47511	BARE-SC-127-M	Bare Fiber Adaptor with SC connector, for 125 micron diameter fibers, magnetic clamp
47510	BARE-LC-127-M	Bare Fiber Adaptor with LC connector, for 125 micron diameter fibers, magnetic clamp
47509	BARE-E-127-M	Bare Fiber Adaptor with E2000 connector, for 125 micron diameter fibers, magnetic clamp

ORDERING INFORMATION:

BARE FIBER ADAPTOR:

BARE-0X-b(-M)

← Add “-M” to the part number for magnetic clamp version

X: Connector type:
 3 = FC connector
 5 = SMA 905 connector
 8 = ST connector
 SC = SC connector
 LC = LC connector
 E = E2000 connector

b: Ferrule hole size, in microns.
 80–250 micron
 Ask factory for standard and custom hole sizes.

Ordering Example: A FC style Bare fiber adaptor for 125 micron fiber with standard spring clamp, part #: **BARE-03-127**.
 Same part with magnetic clamp, part #: **BARE-03-127-M**.

Optional accessories

Bar Code	Part Number	Description
36277	F1-8265-80	80 µm piano wire
1934	F1-8265	125 µm piano wire
1932	Cleaver-01	Cleaving Pen
1938	F103-S	Miller Stripper

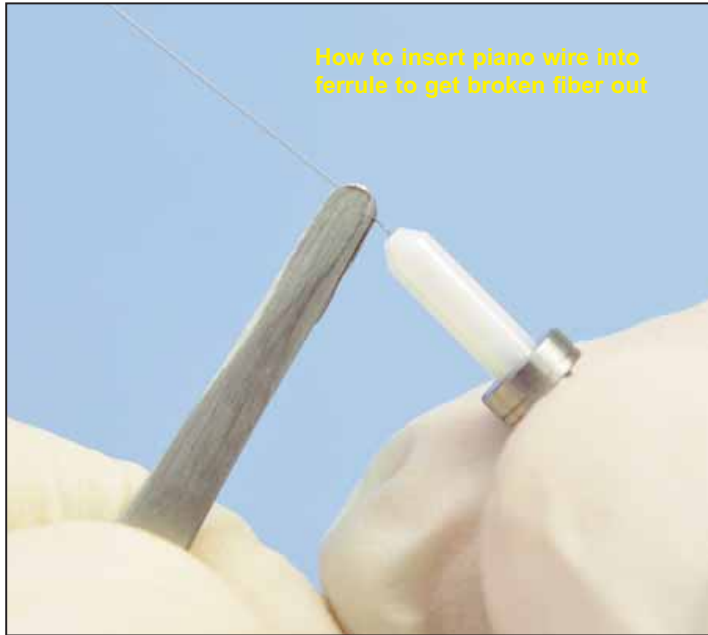

How to insert piano wire into ferrule to get broken fiber out

Cleaning/Maintenance: Broken fibers are easily removed with piano wire, allowing hundreds of insertions. Piano wire can be purchased from OZ Optics. Bar code #36277 for 80 μm and bar code #1934 for 125 μm piano wire.

OPERATING INSTRUCTIONS:

Note: When using alcohol and acetone, carefully follow all safety, health and disposal information given on the container label, and on any material safety data sheets.

Method 1

1. If you are using the bare fiber adaptor with uncabled fiber, proceed to step 2. If you are using cabled fibers, strip at least 3 inches of the cable's outer jacket and cut away the exposed strength members (usually Kevlar fibers near the stripped edge).
2. Strip a sufficient amount of the buffer to allow for fiber insertion. The length of buffer stripped should be approximately 15 mm to 20 mm.
3. Clean the exposed cladding with acetone and/or isopropyl alcohol (reagent grade).
- 4a. Magnetic clamp: Flip open the magnetic clamp. Push the stripped fiber through until the buffer stops the fiber. At this point flip shut the magnetic clamp to hold the fiber in place.
- 4b. Spring clamp: Depress the spring-loaded buffer clamping mechanism and insert the stripped fiber into the acceptance hole. Push the stripped fiber through until the buffer stops the fiber. At this point release the buffer clamping mechanism, to hold the fiber in place.
5. Use a cleaving pen to gently score the fiber as close to the ferrule end as possible. (See Figure 2) Note: If the fiber breaks during the scoring process, it means that the score was too deep, which will result in a poor fiber end face and high losses.
6. Pull the scored fiber directly up. The scored fiber should separate cleanly at the score point. Note: Always pull the fiber directly up. Failure to do so will result in a poor fiber end face and high losses.
7. Inspect the end face with an eye loop and if necessary, adjust the fiber until it is flush.
8. The fiber is now ready for use. Insert the adaptor into the optical test equipment's receptacle.

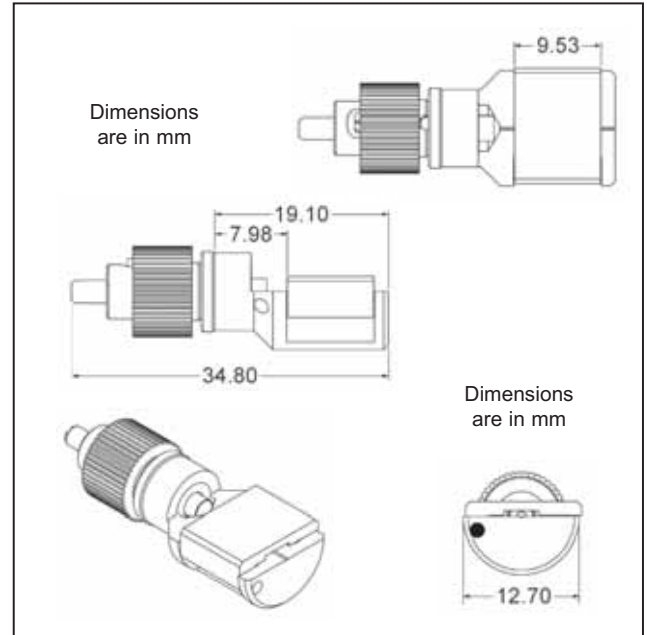

Figure 1. FC Bare Fiber Adaptor with Magnetic Clamp.

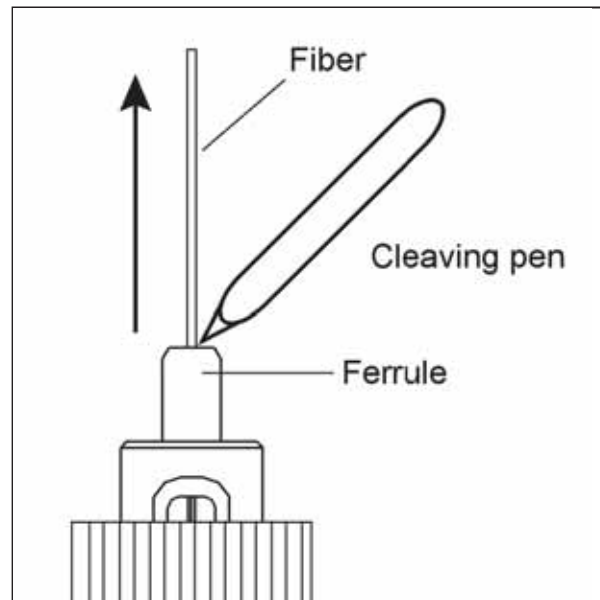

Figure 2. Score fiber with cleaving pen and separate the fiber by pulling up.

OPERATING INSTRUCTIONS *(continued)*

Method 2

1. If you are using the bare fiber adaptor with uncabled fiber, proceed to step 2. If you are using cabled fibers, strip at least 3 inches of the cable's outer jacket and cut away the exposed strength members (usually Kevlar fibers near the stripped edge).
2. Strip a sufficient amount of the buffer to allow for fiber cleaving. The length of buffer stripped from the fiber will depend on the type of cleaver used. (Usually 25 mm to 35 mm is adequate).
3. Clean the exposed cladding with acetone and/or isopropyl alcohol (reagent grade).
4. Cleave the fiber, leaving approximately 11 mm to 13 mm of exposed fiber. (See Figure 3).
- 5a. Magnetic clamp: Flip open the magnetic clamp. Push the fiber through until the cleaved fiber end is flush with the ceramic ferrule end face. At this point flip shut the magnetic clamp to hold the fiber in place.
- 5b. Spring clamp: Depress the spring-loaded buffer clamping mechanism and insert the cleaved fiber into the acceptance hole. Push the fiber through until the cleaved fiber end is flush with the ceramic ferrule end face. At this point release the buffer clamping mechanism, to hold the fiber in place.
6. Inspect the end face with an eye loop and if necessary, adjust the fiber until it is flush.
7. The fiber is now ready for use. Insert the adaptor into the optical test equipment's receptacle.

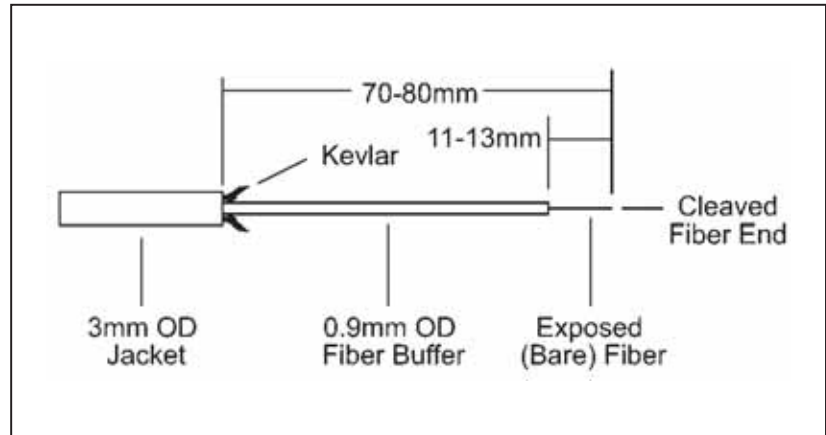

Figure 3. Bare fiber preparation of 3 mm OD jacketed fiber for bare fiber adaptors. (900 micron OD tight buffer version for this configuration).