



OZ Optics

www.ozoptics.com

219 Westbrook Rd, Ottawa, ON, Canada, K0A 1L0 Toll Free: 1-800-361-5415 Tel:(613) 831-0981 Fax:(613) 836-5089 E-mail: sales@ozoptics.com

FIBER OPTIC CIRCULATORS

Features

- Low insertion loss
- Miniature packages
- High power handling
- Wide wavelength range
- Low cross talk
- Center wavelengths 1310,1480,1550 nm
- Low return loss
- High extinction ratio
- High isolation
- Singlemode and polarization maintaining fiber versions available

Applications

- DWDM networks
- Chromatic dispersion compensation
- Optical add drop modules (OADM)
- Fiber amplifiers
- Fiber sensors

Product Description

Fiber optic circulators act as signal routers, transmitting light from an input fiber to an output fiber, but directing light that returns along that output fiber to a third port. They perform a similar function as an isolator, protecting the input fiber from return power, but also allowing the rejected light to be employed.

OZ Optics' fiber optic circulators are manufactured with polarization maintaining fibers making them ideal for polarization maintaining applications such as 40 Gbit systems or Raman pump applications. They are also used in double pass amplifiers and in chromatic dispersion compensation modules.

The standard fiber alignment is for all power to be transmitted along the slow axis of each fiber. With OZ Optics' modular design and custom manufacturing capabilities, any of the three ports can be aligned for fast axis coupling. High extinction ratio connectors can also be installed. Regardless of the state of

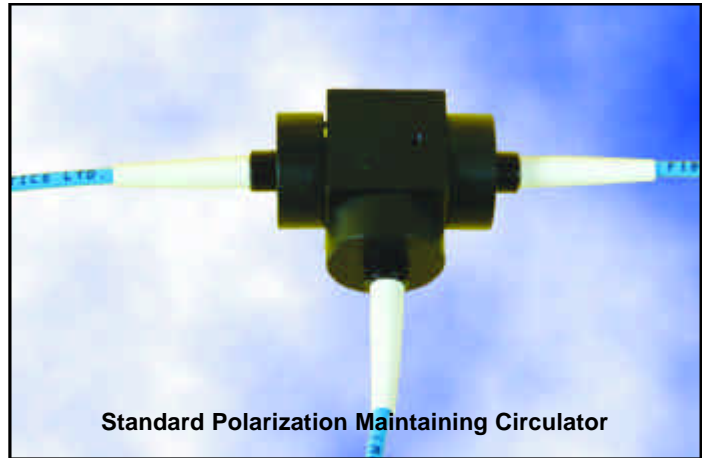

Standard Polarization Maintaining Circulator

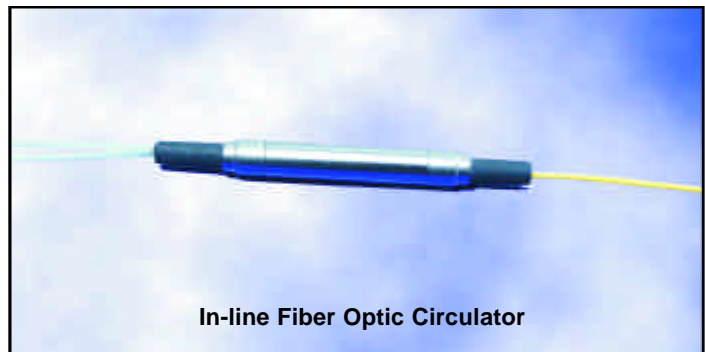

In-line Fiber Optic Circulator

polarization of the return beam, the input fiber will still be isolated from reflected light.

OZ Optics now offers miniature devices for OEM applications. Polarization independent circulators using singlemode fibers are also now available. Additional connector and cable options and custom designs are also available. Please forward a detailed description of your application requirements to the OZ Optics Sales Department.

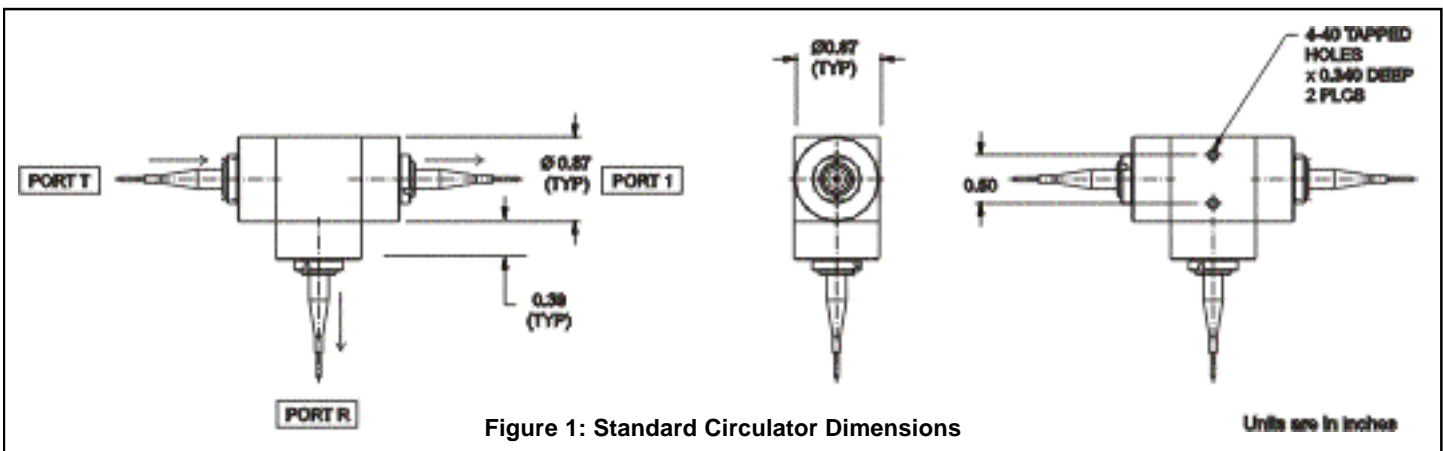

Figure 1: Standard Circulator Dimensions

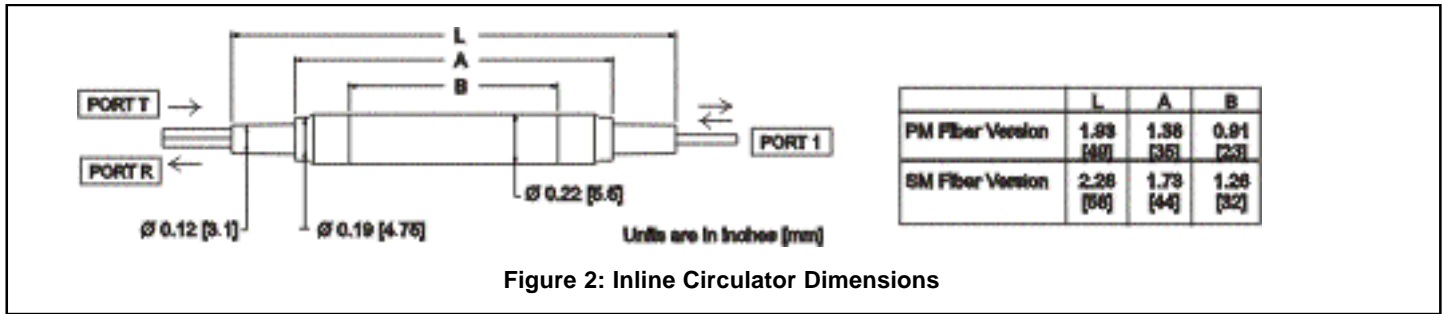

Figure 2: Inline Circulator Dimensions

Standard Product Specifications

Description	Units	Value
Wavelengths	nm	1310, 1480, 1550
Extinction ratio	dB	20, 25, 30
Insertion loss, forward direction	dB	1.0 (40, 50 dB return loss versions) 0.7 (60 dB return loss versions)
Insertion loss, reverse direction	dB	1.0 (40, 50 dB return loss versions) 1.0 (60 dB return loss versions)
Peak isolation @ 23°C	dB	>30 ¹ , <40 ²
Power handling	mW	250 mW
Transmission axis		Slow (standard)
Fiber		Panda PM
Return loss	dB	40, 50, 60
Connector alignment		Slow axis to key

¹ >30 for standard size version
² >40 for miniature in-line version

Standard Parts

Bar Code	Part Number	Description
XXXXX	FOC-12P-111-7/125-PPP-1310-40-XXX-1-1	Polarization maintaining fiber optic circulator for 1310 nm with 40dB return loss, with 1 meter long, 1 mm OD cabled 7/125 PM fiber pigtailed, with no connectors.
XXXXX	FOC-12P-111-8/125-PPP-1480-60-XXX-1-1	Polarization maintaining fiber optic circulator for 1480 nm with 60dB return loss, with 1 meter long, 1 mm OD cabled 8/125 PM fiber pigtailed, with no connectors.
15114	FOC-12P-111-8/125-PPP-1550-60-XXX-1-1	Polarization maintaining fiber optic circulator for 1550 nm with 60dB return loss, with 1 meter long, 1 mm OD cabled 8/125 PM fiber pigtailed, with no connectors.
XXXXX	FOC-12N-111-9/125-SSS-1310-60-XXX-1-1	Miniature inline fiber optic circulator for 1310 nm with 60dB return loss, with 1 meter long, 1 mm OD cabled Corning SMF-28 fiber pigtailed, with no connectors.
XXXXX	FOC-12N-111-9/125-SSS-1480-60-XXX-1-1	Miniature inline fiber optic circulator for 1480 nm with 60dB return loss, with 1 meter long, 1 mm OD cabled Corning SMF-28 fiber pigtailed, with no connectors.
XXXXX	FOC-12N-111-9/125-SSS-1550-60-XXX-1-1	Miniature inline fiber optic circulator for 1550 nm with 60dB return loss, with 1 meter long, 1 mm OD cabled Corning SMF-28 fiber pigtailed, with no connectors.

Ordering Examples For Standard Parts

Example 1: A circulator is being used to route signals in an Erbium doped fiber amplifier, operating at 1480 nm. To optimize the amplifier stability, polarization maintaining fiber is being used. All connections will be spliced.

Bar Code	Part Number	Description
XXXXX	FOC-12P-111-8/125-PPP-1480-60-XXX-1-1	Polarization maintaining fiber optic circulator for 1480 nm with 60dB return loss, with 1 meter long, 1 mm OD cabled 8/125 PM fiber pigtailed, with no connectors.

Example 2: Circulators are needed for the construction of a 1550 nm WDM demultiplexor system. The circulators will be fusion spliced together with a series of Bragg gratings to demultiplex the signal (see the application notes for an example), so connectors are not required. The wavelengths range from 1540 nm to 1560 nm. Based on this wavelength range, circulators designed for 1550 nm will work well. Miniature style circulators are needed to minimize space. Low return losses are necessary for correct operation.

Bar Code	Part Number	Description
XXXXX	FOC-12N-111-9/125-SSS-1550-60-XXX-1-1	Miniature inline fiber optic circulator for 1550 nm with 60dB return loss, with 1 meter long, 1 mm OD cabled Corning SMF-28 fiber pigtailed, with no connectors.

Ordering Information For Custom Parts

OZ Optics welcomes the opportunity to provide custom designed products to meet your application needs. As with most manufacturers, customized products do take additional effort, so please expect some differences in the pricing compared to our standard parts list. In particular, we will need additional time to prepare a comprehensive quotation, and lead times will be longer than normal. In most cases, non-recurring engineering (NRE) charges, lot charges, and minimum order quantities will be necessary. These points will be carefully explained in your quotation, so your decision will be as well informed as possible. We strongly recommend buying our standard products.

Questionnaire For Custom Parts

1. What is your operating wavelength, in nm?
2. Do you prefer a standard or inline style package?
3. Are you using singlemode or polarization maintaining fiber?
4. What are the minimum return loss requirements?
5. How long should the fibers be and what fiber type?
6. Do you require connectors? If so, what type?
7. How much power will be transmitted through the fiber?

Description

Part Number

Fiber Optic Circulator

FOC-12P-11-a/b-PPP-W-LB-XYZ-JD- L

Circulator Type:

- P for standard style
- N for miniature inline style

Fiber Core/Cladding Sizes, in microns

7/125 for 1300 nm polarization maintaining fiber
 8/125 for 1550 nm polarization maintaining fiber
 9/125 for 1300/1550 nm singlemode fiber
 See Tables 1 and 2 of the Standard Tables for other standard fiber sizes

Fiber Type:

- S for singlemode
- P for polarization maintaining

Wavelength: Specify in nanometers

(Example: 1550 for 1550 nm)

Backreflection Level: 40, 50 or 60dB

Fiber Length in meters

Fiber Jacket Type:

- 0.25 = 250 Micron OD acrylate jacket
 - 1 = 900 micron OD hytrel jacket
 - 3 = 3 mm OD Kevlar reinforced PVC cable
- See Table 7 of the Standard Tables for other jacket sizes

Connector Code:

- 3 = NTT - FC/PC
 - 3S = Super NTT-FC/PC
 - 3U = Ultra NTT-FC/PC
 - 3A = Angled NTT-FC/PC
 - 8 = AT&T-ST
 - SC = SC
 - SCA = Angled SC
- See Table 6 of the Standard Tables for other connectors.

Ordering Example For Custom Parts

A customer is building a fiber laser, and is using a circulator to direct the input light and amplified return signal. The operating wavelength is 1550 nm, and uses polarization maintaining fiber. He wants a reconfigurable system, so he wants angled FC connectors on the fiber ends. He also wants 3 mm cable on the fibers as he wants rugged units that can withstand repeated handling. One meter long fibers are sufficient.

Bar Code	Part Number	Description
XXXXX	FOC-12P-111-8/125-PPP-1550-60-3A3A3A-3-1	Polarization maintaining fiber optic circulator for 1550 nm with 60dB return loss, with 1 meter long, 3 mm OD cabled 8/125 PM fiber pigtails, with FC/APC connectors on all ends.

Frequently Asked Questions (FAQs)

- Q.** Can I use a polarization maintaining circulator with singlemode fiber?
- A.** Not without seeing high insertion losses. The transmission through polarization maintaining circulators is highly polarization dependent. Only the return output port can be made using singlemode fiber without affecting performance. One alternative is to use an all-fiber polarization controller on the inputs to control the polarization through the unit. Otherwise, we recommend the miniature units.
- Q.** What happens to light polarized along the wrong axis?
- A.** Fast axis light in port T is absorbed internally, as is fast axis light returning into the circulator.

- Q.** Why do I get high losses?
- A.** Check to see that you are launching light through the proper polarization axis of the proper fiber port.
- Q.** Can I get a higher isolation or extinction ratio?
- A.** OZ Optics can supply circulators with 25dB and 30dB extinction ratios and can make design modifications for higher isolation values. Please forward you system requirements for a proposal.

Application Notes:

Circulators for Non-Standard Wavelengths: Due to limits in rotator size, OZ Optics does not typically offer circulators for wavelengths below 1300 nm. However, a Polarizing Fiber Optic Beamsplitter and a Pigtailed Faraday Rotator can be connected to accomplish the same function. Both devices are pigtailed with PM fiber. The light along the slow axis is transmitted through the beamsplitter and through the rotator. The output fiber from the rotator is oriented at 45 degrees relative to the input fiber. When light travels back along the slow axis of the fiber towards the rotator, it is rotated an additional 45 degrees and now travels through the fast axis towards the Beamsplitter. Fast axis light is reflected through the third port of the Beamsplitter, which accomplishes the same effect as a circulator without having to design a custom assembly.

Application Examples:

Duplex Transmitter/Receiver System: Circulators can be used to enable 2-way transmission along a single fiber. Transmitter 1 sends signal through Port 1 of Circulator 1 and through the fiber to Port 2 of Circulator 2 so that it is directed to Receiver 2. The signal from Transmitter 2 follows the opposite path to Receiver 1. See Figure 3.

Double Pass Erbium Doped Amplifier: This technique allows high gain amplification of a signal through an erbium doped fiber amplifier. The signal passes through the circulator and amplifier, returns from the Fiber Optic Reflector (also available from OZ Optics) and passes through the amplifier again. This amplified signal is directed through the return port. See Figure 4.

Chromatic Dispersion Compensator: Light that has become chromatically dispersed after traveling through a system passes through a circulator and enters a chirped Bragg grating. This grating is made so that faster wavelengths are reflected at the far end of the filter (therefore experiencing a longer optical path) and slower wavelengths reflected at the near end of the filter (shorter optical path). These path differences compress the signal back to its original width.

Wave Division Multiplexing System: Circulators in conjunction with Bragg gratings allow specific wavelengths to be reflected and sent down different paths. See Figure 5.

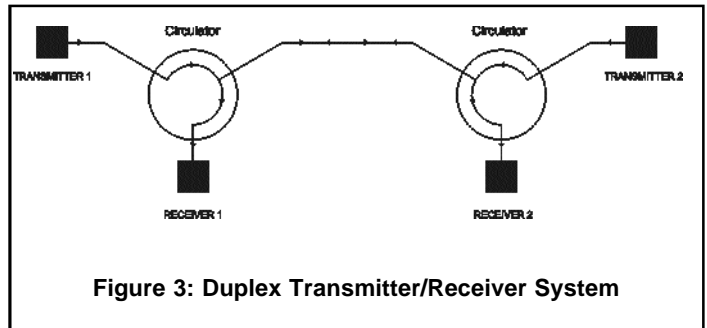

Figure 3: Duplex Transmitter/Receiver System

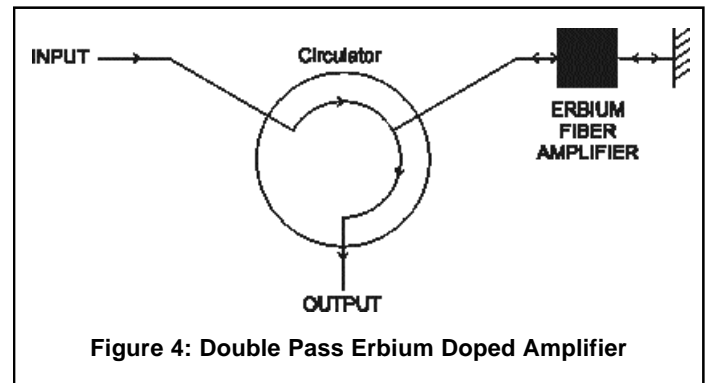

Figure 4: Double Pass Erbium Doped Amplifier

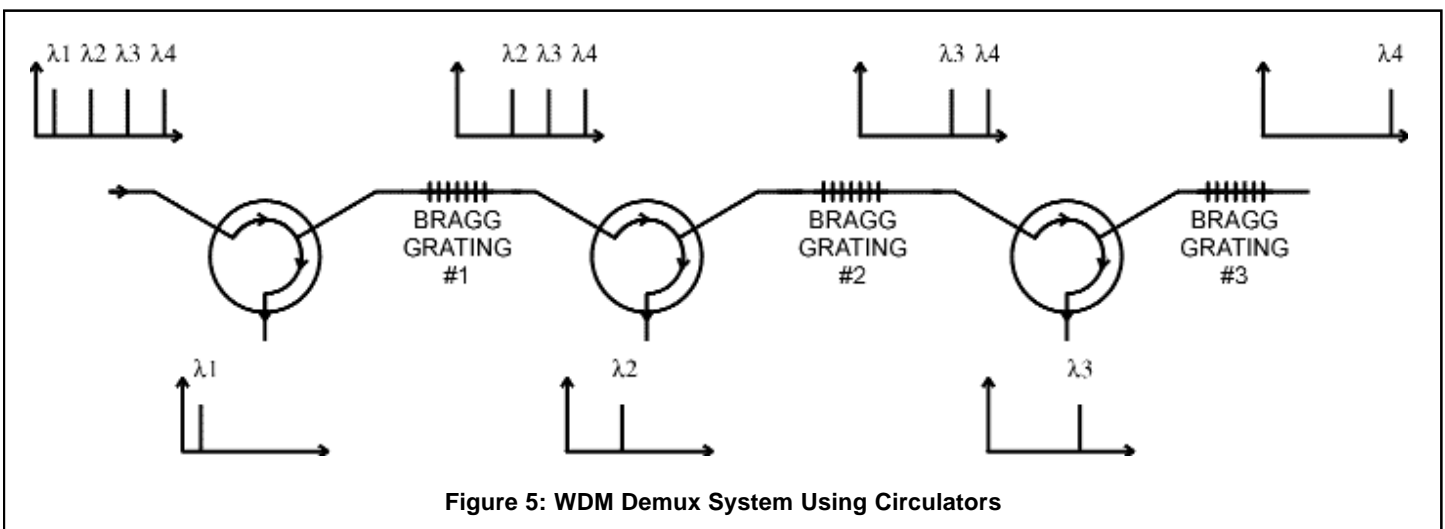

Figure 5: WDM Demux System Using Circulators