

FEATURES

- High output voltage 12.5 V_{pp}
- High gain 29 dB
- Flat gain up to 20 GHz
- Single voltage power supply

APPLICATIONS

- LiNbO₃ & InP modulators
- 22 Gbps DPSK
- 2x20 Gbps (D)QPSK
- Research & Development

OPTIONS

- 13.5 V_{pp} output voltage
- Heat-sink
- Analog version
- Low output voltage version for EAM

RELATED EQUIPMENTS

- MXIQER-LN-40, MX-LN-20 modulators
- MBC-DG Automatic Bias Controllers

The DR-DG-20-HO is a driver module optimized for digital applications requiring an upper operation voltage. It exhibits 12.5 V_{pp} output voltage and 29 dB gain up to 23 GHz.

The DR-DG-20-HO module is especially useful for driving LiNbO₃ modulators with 22 Gbps DPSK and 2x20 Gbps (D)QPSK modulation formats. It is operated from a single power supply voltage for safety and ease of use and offers gain and cross-point control.

The DR-DG-20-HO comes with K type RF connectors (female in, male out) and with an optional heat-sink. It is a non-inverting and single ended amplifier.

Performance Highlights

Parameter	Min	Typ	Max	Unit
Cut-off Frequencies	80 k	23 G	25 G	Hz
Output Voltage	-	12.5	13.5	V _{pp}
Gain	-	29	-	dB
Saturated Power	26	-	-	dBm
Added Jitter	-	1.05	-	ps
Rise / Fall Times	-	12 / 16	-	ps

Measurements for V_{bias} = 12 V, V_{amp} = 1.2 V, V_{xp} = 0.7 V, I_{bias} = 550 mA

20 Gbps Output Response

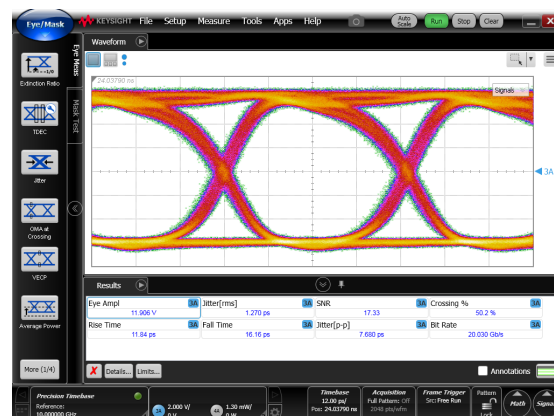

DC Electrical Characteristics

Parameter	Symbol	Min	Typ	Max	Unit
Supply voltage (fixed)	V_{bias}	-	12	13	V
Current consumption	I_{bias}	-	0.53	0.58	A
Gain control voltage	V_{amp}	0	1.5	2	V
Cross point control voltage	V_{xp}	0	0.7	1	V

Electrical Characteristics

Parameter	Symbol	Condition	Min	Typ	Max	Unit
Lower frequency	f_{3db} lower	-3 dB point	-	-	80	kHz
Upper frequency	f_{3db} upper	-3 dB point	-	23	25	GHz
Gain	S_{21}	Small signal	-	29	-	dB
Gain ripple	-	< 17 GHz	-	± 1.5	-	dB
Input return loss	S_{11}	50 kHz < f < 18 GHz	-	-10	-	dB
Output return loss	S_{22}	50 kHz < f < 15 GHz	-	-10	-	dB
Saturated power	P_{sat}	$V_{in} = 0.65 V_{pp}$	26	-	-	dBm
Output voltage	V_{out}	$V_{in} = 0.65 V_{pp}$ @ 20 Gbps	-	12.5	13.5 ($V_{in} = 1V_{pp}$)	V_{pp}
Rise time / Fall time	t_r / t_f	20 % - 80 %	-	12 / 16	-	ps
Added jitter	J_{RMS}	$J_{RMS} = \sqrt{J_{RMS-total}^2 - J_{RMS-source}^2}$	-	1.05	-	ps
Power dissipation	P	$V_{out} = 12.5 V_{pp}$	-	6.4	-	W

Conditions: $V_{in} = 0.65 V_{pp}$, $T_{amb} = 25$ °C, 50 Ω system

Absolute Maximum Ratings

Stresses in excess of the absolute maximum ratings can cause permanent damage to the device. These are absolute stress ratings only. Functional operation of the device is not implied at these or any other conditions in excess of those given in the operational sections of the data sheet. Exposure to absolute maximum ratings for extended periods can adversely affect device reliability.

Parameter	Symbol	Min	Max	Unit
RF input voltage	V_{in}	-	0.8	V_{pp}
Supply Voltage	V_{bias}	-	13	V
DC current	I_{bias}	-	0.58	A
Gain control voltage	V_{amp}	0	2	V
Cross point control voltage	V_{xp}	0	1	V
Power dissipation	P_{diss}	-	7.3	W
Temperature of operation	T_{op}	0	+40	°C
Storage temperature	T_{st}	-10	+70	°C

S₂₁ Parameter Curve

Conditions: $V_{bias} = 12\text{ V}$, $V_{amp} = 1.2\text{ V}$, $V_{xp} = 0.7\text{ V}$, $I_{bias} = 550\text{ mA}$

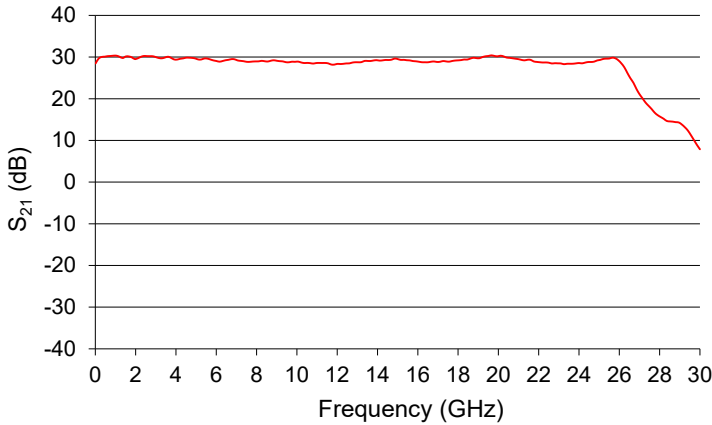

Group Delay Parameter Curve

Conditions: $V_{bias} = 12\text{ V}$, $V_{amp} = 1.2\text{ V}$, $V_{xp} = 0.7\text{ V}$, $I_{bias} = 550\text{ mA}$

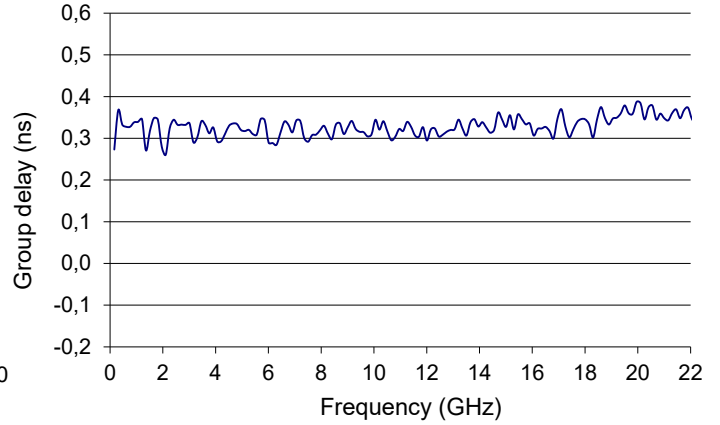

S₂₂ Parameter Curve

Conditions: $V_{bias} = 12\text{ V}$, $V_{amp} = 1.2\text{ V}$, $V_{xp} = 0.7\text{ V}$, $I_{bias} = 550\text{ mA}$

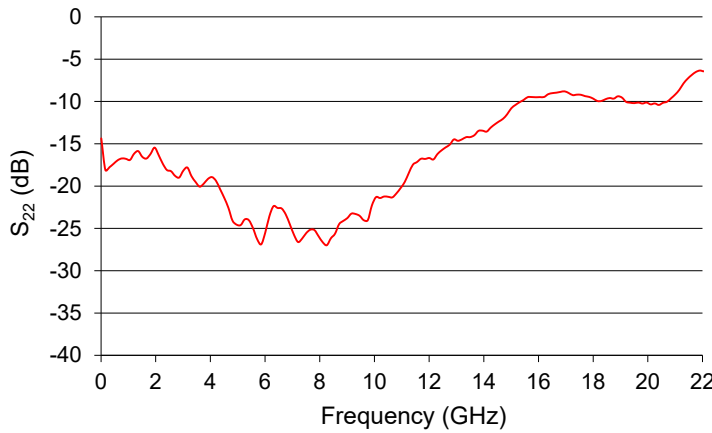

S₁₁ Parameter Curve

Conditions: $V_{bias} = 12\text{ V}$, $V_{amp} = 1.2\text{ V}$, $V_{xp} = 0.7\text{ V}$, $I_{bias} = 550\text{ mA}$

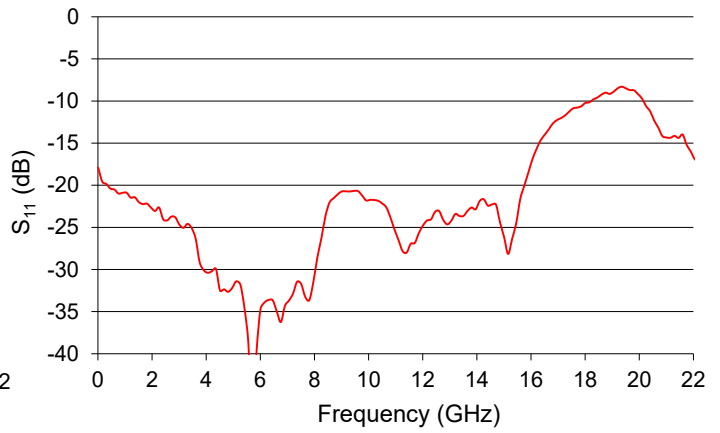

S₁₂ Parameter Curve

Conditions: $V_{bias} = 12\text{ V}$, $V_{amp} = 1.2\text{ V}$, $V_{xp} = 0.7\text{ V}$, $I_{bias} = 550\text{ mA}$

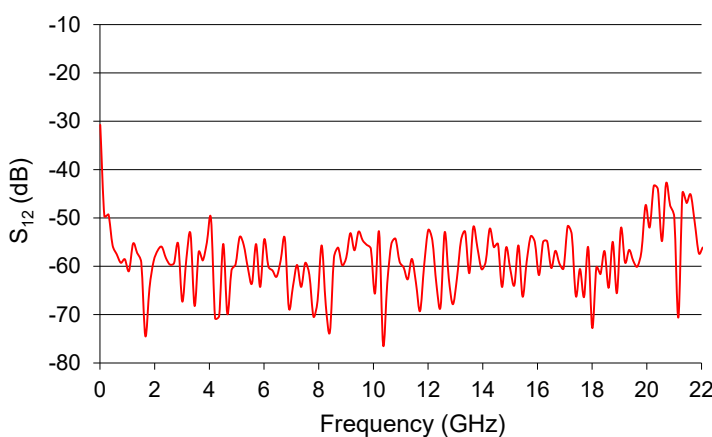

Noise Factor Curve

Conditions: $V_{bias} = 12\text{ V}$, $V_{amp} = 1.2\text{ V}$, $V_{xp} = 0.7\text{ V}$, $I_{bias} = 550\text{ mA}$

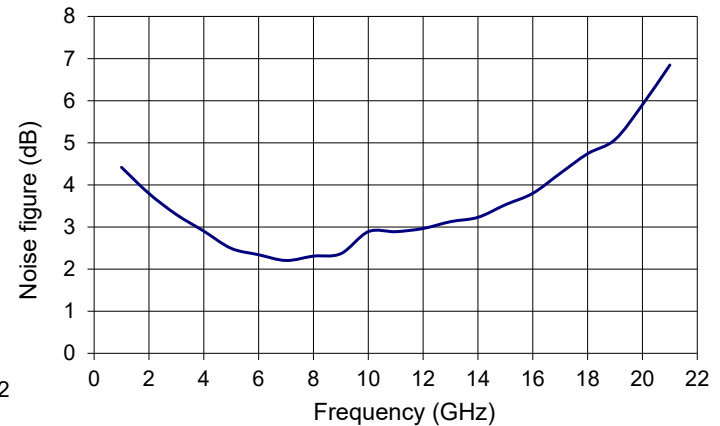

Eye Diagrams

10 Gbps data rate

Conditions: Ratio 1/2, Pattern 2³¹-1

$$V_{\text{bias}} = 12\text{ V}, V_{\text{amp}} = 1.4\text{ V}, V_{\text{xp}} = 0.7\text{ V}, I_{\text{bias}} = 501\text{ mA}$$

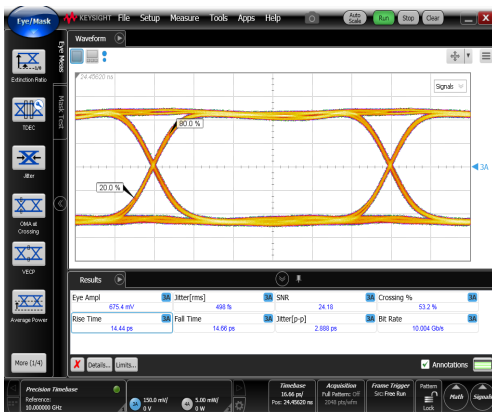

Input signal
Eye amplitude = 0.66 V_{pp}

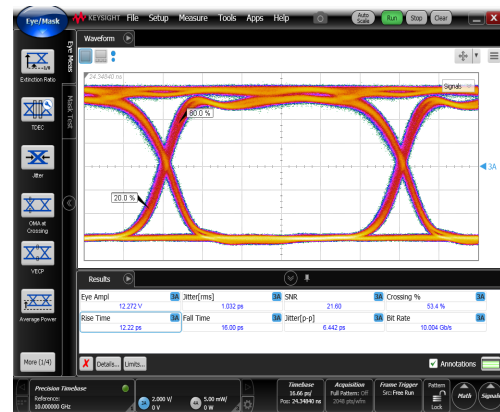

Output response
Eye amplitude = 12.2 V_{pp}

20 Gbps data rate

Conditions: Ratio 1/2, Pattern 2³¹-1

$$V_{\text{bias}} = 12\text{ V}, V_{\text{amp}} = 1.5\text{ V}, V_{\text{xp}} = 0.8\text{ V}, I_{\text{bias}} = 575\text{ mA}$$

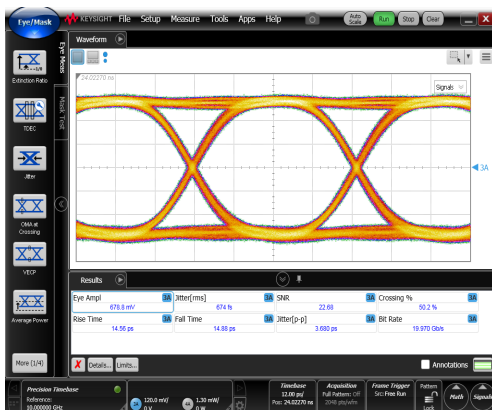

Input signal
Eye amplitude = 0.66 V_{pp}

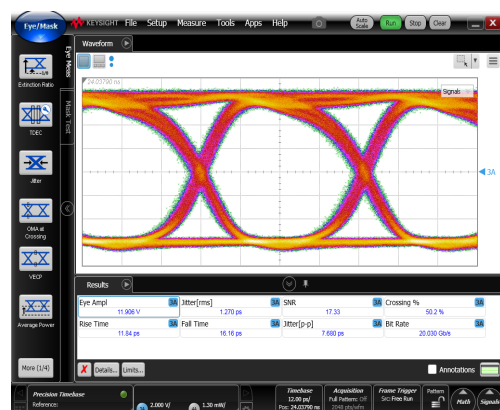

Output response
Eye amplitude = 11.9 V_{pp}

Electrical Schematic Diagram

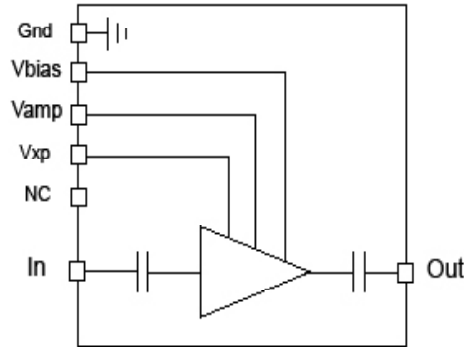

Mechanical Diagram and Pinout

All measurements in mm

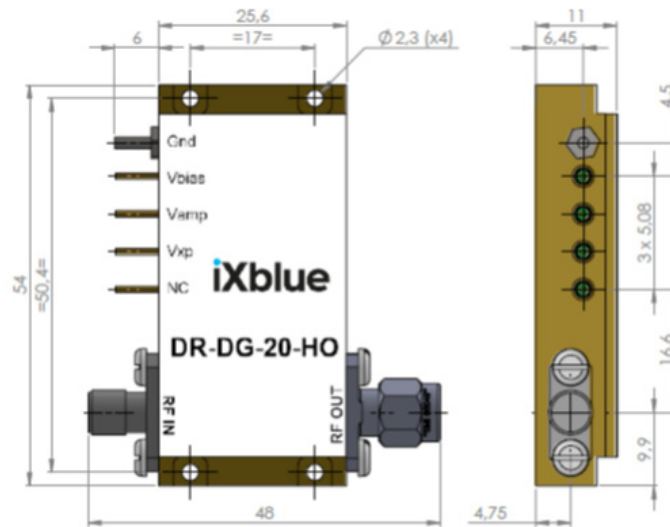

The heat-sinking of the module is necessary. It's user responsibility to use an adequate heat-sink. Refer to page 6 for ixblue recommended heat-sink.

PIN	Function	Unit
IN	RF In	K connector female
OUT	RF Out	K connector male
V_{bias}	Power supply voltage	Set a typical operating specification
V_{amp}	Output voltage amplitude adjustment	Adjust for gain control tuning
V_{xp}	Output voltage cross point adjustment	Adjust for cross point control tuning

Mechanical Diagram And Pinout With HS-HO1 Heat-sink

All measurements in mm

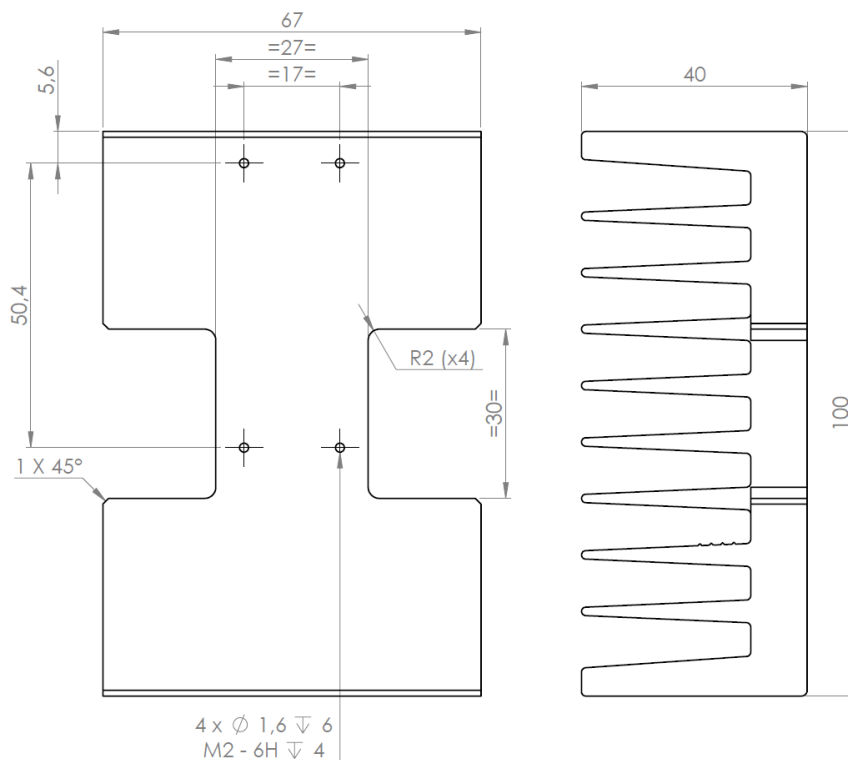
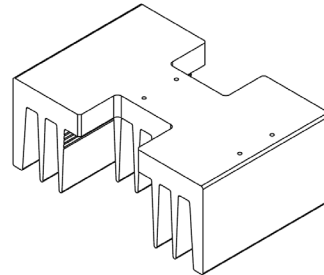

About us

ixblue Photonics produces specialty optical fibers and Bragg gratings based fiber optics components and provides optical modulation solutions based on the company lithium niobate (LiNbO₃) modulators and RF electronic modules.

ixblue Photonics serves a wide range of industries: sensing and instruments, defense, telecommunications, space and fiber lasers as well as research laboratories all over the world.