

DENSELIGHT SEMICONDUCTORS PTE. LTD.
6 Changi North St. 2, S498831 SINGAPORE
Tel: (65) 6415 4488
Fax: (65) 6415 7988
www.denselight.com

SPECIFICATIONS

Ultra Narrow Linewidth 1648nm Laser In BTF Package

DL-CLS051B-S1648

DenseLight Semiconductors reserves the right to make product design or specifications changes without notice.

A. PRODUCT DESCRIPTION

DenseLight **DL-CLS051B-S1648** is a cooled ultra narrow linewidth laser in BTF package with SMF pigtail emitting at 1648nm wavelength. It is engineered for modulation up to 622Mbps. This laser is based on an external cavity laser with built-in fiber Bragg grating, offering very stable performance of lasing wavelength, narrow spectral linewidth and excellent SMSR.

B. FEATURES

- Strained InGaAsP/InP MQW gain chip coupled with built-in fiber Bragg grating
- Lasing wavelength of 1648nm
- Minimum 5mW CW operation
- Minimum SMSR of 45dB
- Linewidth of <200kHz
- Internal thermoelectric cooler and thermistor
- Designed for 155/622Mbps operation
- RoHS Compliance

C. PACKAGING

- 14-pin BTF package with SMF-28 pigtail

D. APPLICATIONS

- OTDR
- Optical measuring instrumentation
- Optical gas and chemical sensor

E. ABSOLUTE MAXIMUM RATINGS

Parameter	Symbol	Condition	Min	Max	Unit
Reverse voltage	V_R			2	V
Forward current	I_F			120	mA
Forward voltage	V_F	I_{op}		2.5	V
Case temperature	T_c	I_{op}	0	60	°C
Laser temperature ¹	T_{Laser}	I_{op}	0	70	°C
Thermoelectric cooler voltage	V_{TEC}			3.0	V
Thermoelectric cooler current	I_{TEC}			1.8	A
Storage temperature	T_{stg}	Unbiased	-40	85	°C
Storage humidity			5	85	%RH
Electro static discharge (ESD)	V_{ESD}	Human body model		500	V
Lead soldering temperature	S_{temp}			260	°C
Lead soldering time	S_{time}			10	sec

¹ T_{Laser} is monitored by internal thermistor with external pin out.

F. ELECTRICAL AND OPTICAL CHARACTERISTICS

($T_{Laser} = 25\text{ °C}$, unless otherwise noted)

Parameter	Symbol	Test Conditions	Min	Typ	Max	Unit
Optical output power	P_O	CW	5	–	–	mW
Threshold current	I_{th}	CW	–	25	35	mA
Operating current	I_{op}	CW, 5mW	–	–	70	mA
Operation voltage	V_{op}	CW, 5mW	–	1.5	1.8	V
Slope efficiency	η	CW, 5mW	0.06	0.1	–	mW/mA
Peak wavelength	λ_p	CW, 5mW	1646	1648	1650	nm
Side mode suppression ratio	SMSR	CW, 5mW	45	–	–	dB
Linewidth ²	$\Delta\lambda$	CW, 5mW	–	200	–	kHz
Thermistor resistance	R_{therm}	$T_{therm} = 25\text{°C}$	9.5	10	10.5	k Ω

² Typical linewidth is narrowed to < 10kHz when module is integrated inside DenseLight's BF-series box with high precision laser driver & temperature controller.

G. PACKAGE

Part	Description
Package type	14-pin BTF
Fiber:	SMF-28
MFD	9 μ m
Cladding diameter	125 μ m
Coating diameter	245 μ m
Fiber pigtail length	>1m
Fiber connector	FC/APC

H. OUTLINE DRAWINGS

Typical Package Dimension

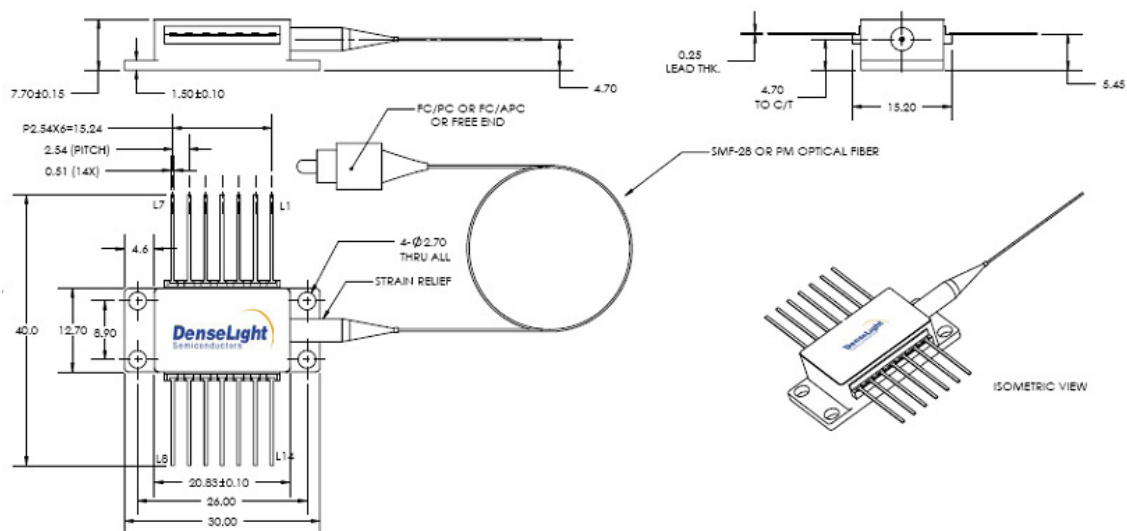

Pin Assignment	
1	TEC (+)
2	THERMISTOR
3	
4	
5	THERMISTOR
6	-
7	-
8	-
9	-
10	LD ANODE (+)
11	LD CATHODE (-)
12	-
13	CASE
14	TEC (-)

