

DFB-15XX-DM-3

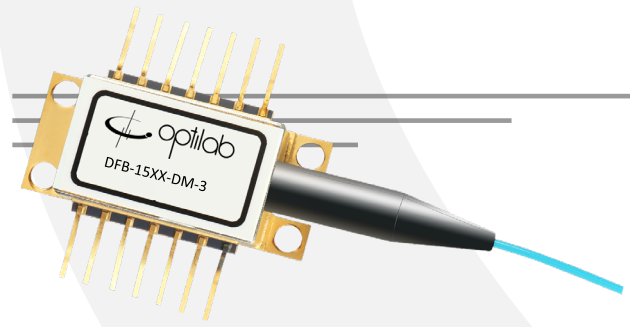

DEVICE

DFB Laser Diode, 15XX nm, 3 GHz, 20 mW, Single Mode

OVERVIEW

The Optilab DFB-15XX-DM-3 Directly-Modulated (DM) DFB laser is a high-speed 15XX nm wavelength laser source for 3 GHz analog or 4 Gb/s digital transmission optical link. Built with Distributed Feed-Back Grating (DFB) as cavity reflector, it provides pure, single longitudinal mode, hopping free and extremely stable wavelength source. This laser diode is fabricated with Multiple Quantum Well (MQW) for excellent reliability and stability. It can be used for CW operation for fiber sensor or coherence interferometer. Or with direct current modulation DFB-15XX-DM-3 can be used for DC to 3 GHz analog or up to 4 Gb/s digital modulation. The wavelength choice is from 1529 to 1561 nm. This MQW DFB laser features Up to 20 mW of output optical power, good Side Mode Suppression Ratio (SMSR) and a built-in thermoelectric cooler, thermistor, and rear-facet monitor photodiode for external optical power control. Contact Optilab for more information.

FEATURES

- MQW laser structure with ECL Design
- Available wavelength: 1529-1561 nm
- Analog modulation up to 3 GHz
- Built-in TEC, Thermistor & Monitor PD
- Up to 20 mW output power typical
- Side Mode Suppression Ratio 50 dB

USE IN

- Stabilized Single Frequency Source
- Analog RF over fiber
- DWDM optical network
- CW 1550 nm laser source
- Directly modulated optical link
- 4 Gb/s digital communication

FUNCTIONAL DIAGRAM

- | | |
|---------------------|-------------------------|
| 1 Thermistor | 8 Case Ground |
| 2 Thermistor | 9 Case Ground |
| 3 Laser DC Bias (-) | 10 Not Connected |
| 4 Monitor Anode | 11 Laser Ground |
| 5 Monitor Cathode | 12 Laser Modulation (-) |
| 6 TEC (+) | 13 Case Ground |
| 7 TEC (-) | 14 Not Connected |

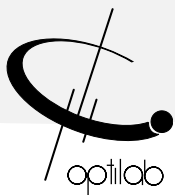
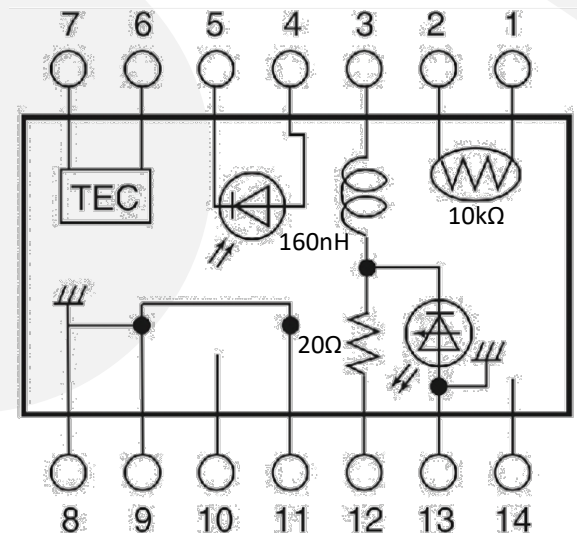

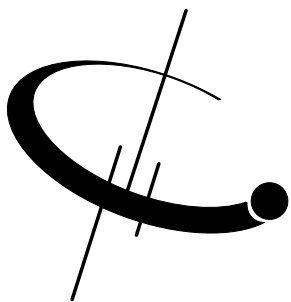

DFB-15XX-DM-3

SPECIFICATIONS

Center Wavelength Range	1529-1561 nm typ.
Optical Output Power	20 mW
Threshold Current	20 mA max. @ CW
Operating Current	350 mA typ. @ CW
Forward Voltage	1.6 V typ.
Series Resistance	20 Ω typ.
Slope Efficiency	0.1 mW/mA typ.
Threshold Power	0.15 mW
Monitor Current	0.3 mA @ 1.0 mW
Side Mode Suppression Ratio	50 dB typ.
Laser Linewidth	2 MHz typ.
Rise/Fall Time (10%-90%)	150 ps typ.
3 dB S21 Bandwidth	2.5 GHz
RF Return Loss	-10 dB from DC to 2.5 GHz
Optical Isolation	35 dB typ.
Relative Intensity Noise	-145 dB/Hz max
Optical Connectors	FC/APC
Optical Fiber Type	SMF-28 (standard)

GENERAL & MECHANICAL

ABSOLUTE MAXIMUM RATING

All wavelength/power measurement based on 25°C

Wavelength Tuning Coefficient	0.1 nm/°C
Operating Temperature	-30 °C to +60 °C
Storage Temperature	-40 °C to +75 °C
Reverse Voltage	2 V
LD Current	190 mA
PD Reverse Voltage	10 V
PD Forward Current	10 mA
TEC Voltage	2.5 V
TEC Current	1.4 A
Lead Soldering Time	10 s @ < 260 °C

TEC AND THERMISTOR CHARACTERISTICS

TEC Current	1.0 A max.
TEC Voltage	2.4 V max.
Cooler Power	2.4 W max.
TEC Resistance	2.0 Ω min., 2.4 Ω typ., 3.2 Ω max.
Thermistor Resistance	20 Ω typ.

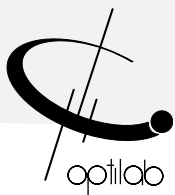

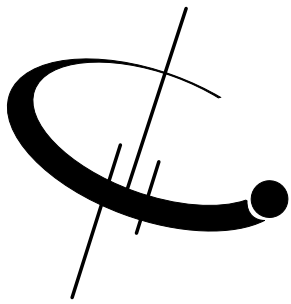

DFB-15XX-DM-3

MECHANICAL DRAWING

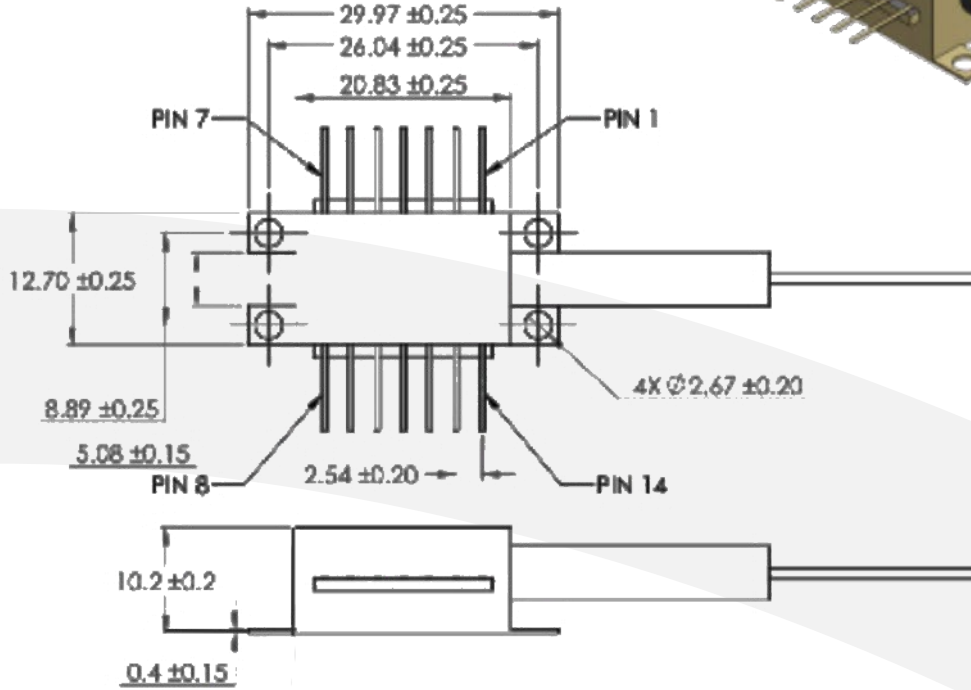
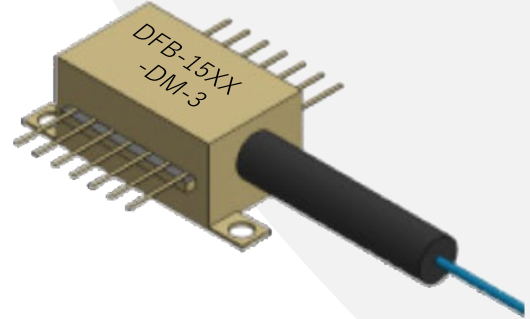

Unit: mm

ORDER OPTION

DFB-15XX-DM-YY	
XX: Wavelength in nanometer	1530 to 1560 nm
YY: Optical power in mW	20 mW

