

# LTA-40



## DEVICE

## 40 GHz Lightwave Transmitter Module for RFoF

## OVERVIEW

The Optilab LTA-40 is a high performance Lightwave Transmitter Module designed for analog photonics applications from DC to 40 GHz. This unit includes a 32 GHz optical intensity modulator and an Automatic Bias Control (ABC) board with four different operating modes. The external laser source can be any polarization maintaining device, such as tunable laser, narrow linewidth laser, making it a versatile solution for RFoF system integration. Contract Optilab for more information.

## FEATURES

- 32 GHz S21 bandwidth modulator
- 1520 nm to 1610 nm wavelength range
- Automatic Bias Control w/ 4 mode operation
- Internal DFB laser up to 50 mW
- Customizable Options:
  - Low Drive Voltage
  - PM Output
  - High Extinction Ratio (>30 dB)
  - Temperature Qualified (-55°C to +75°C)

## USE IN

- Analog photonics
- 40 GHz RFoF transmission
- RF/IF signal distribution
- Satellite communication
- Optical communications to 43 Gb/s
- Picosecond pulse generation

## FUNCTIONAL DIAGRAM

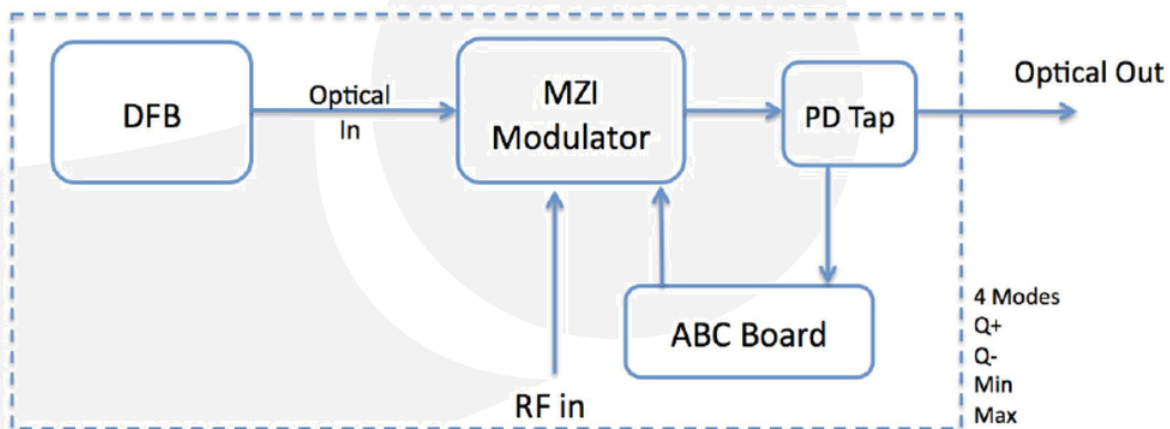

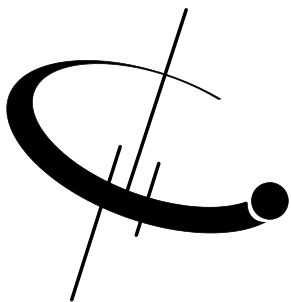

# LTA-40

## SPECIFICATIONS

Operating Wavelength	1520 nm to 1610 nm
Laser Source	Internal DFB laser, 1550nm+/-10nm
Laser Power Level	20 mW, 30 mW, 40 mW, 50 mW
RF Return Loss	>15 dB @ 10 GHz; >10 dB @ 30 GHz

## GENERAL

Operating Frequency Range	DC to 40 GHz
Input RF Voltage	27 dBm max.
Optical Output Level	6.5 dBm typ. w/ 20 mW DFB
S21 Bandwidth	3 dB, 2 GHz to 32 GHz typ.
Modulator Bias Mode	4 Automatic bias control modes, selectable by software
Extinction Ratio	25 dB typ., >30 dB (HE version)
Modulator Voltage	6.4 V typ. @ 10 GHz; 8.3 V typ. @ 30 kHz; 2.5 V typ. @ 10 GHz, 4.3 V typ. @ 30 GHz (LD version)

## MECHANICAL

Operating Temperature (standard)	-30°C to +60°C
Operating Temperature (TQ version)	-55°C to +75°C
Storage Temperature	-60°C to +90°C
Power Supply Requirements	+/- 5 V, 1 A typ.
Optical Connectors	FC/APC
Fiber Type	SMF-28 output, PANDA output (PM version)
RF Input Connector	K connector
Power Connector	4 Pin Molex
Remote Control	USB 2.0 software included
Alarm	LED bias mode status
Dimensions	206mm x 102.4mm x 31.5mm

## ANALOG LINK PERFORMANCE

IIP3 @ 7 GHz	29 dBm typ.; 25 dBm typ. (LD version)
1 dB Compression Point @ 10 GHz	16 dBm typ.; 8 dBm typ. (LD version)

## BIAS CONTROL MODE

Q+	Set to quadrature point of positive slope for linear analog modulation
Q-	Set to quadrature point of negative slope for linear analog modulation
Min	Set to min. point of operation for pulse generation of digital modulation
Max	Set to max. point of operation for pulse generation of digital modulation

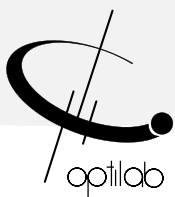

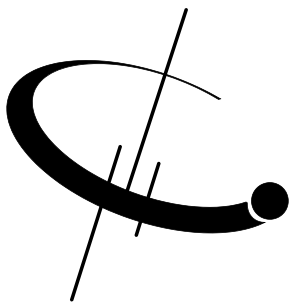

# LTA-40

## TYPICAL S21 AND S11 BANDWIDTH

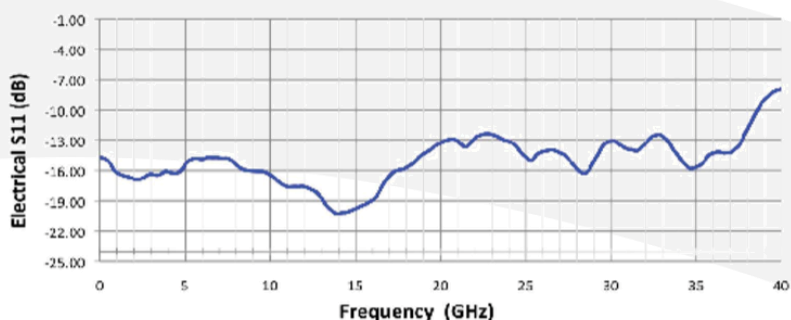
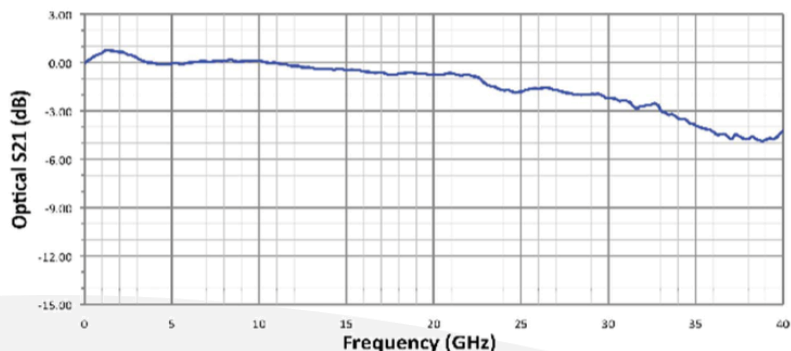

## OPTIONS

### LTA-40-XX-YY

- PM: Polarization Maintaining
- XX:** LD: Low Drive Voltage  
HE: High Extinction Ratio
- YY:** TQ: Temperature Qualified

## BIAS SETTING MODES FOR LTA

Based on sophisticated phase measurement of this small dither signal, LTA-40 provides four selectable operating modes: quadrature (Quad +), inverted quadrature (Quad -), minimum (Min), or maximum (Max) points.

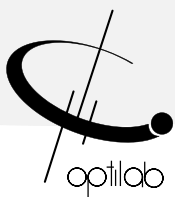
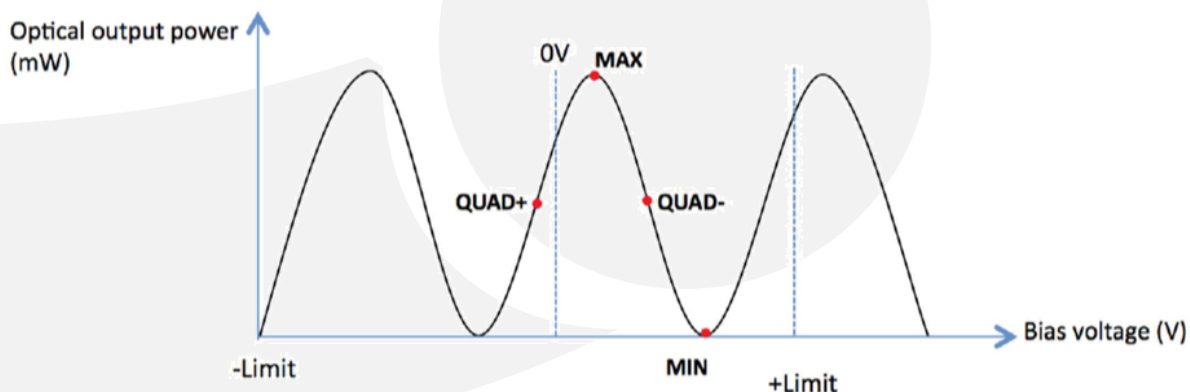

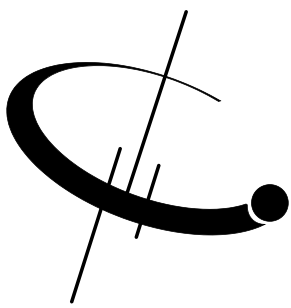

# LTA-40

## DETAILED LAYOUT



No.	Feature
1	Optical Output Port
2	RF Input Port
3	LED Indicators
4	DC Connection Port
5	USB Control and Monitor Port

## MECHANICAL DRAWING

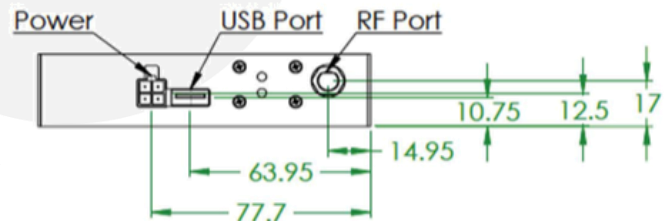
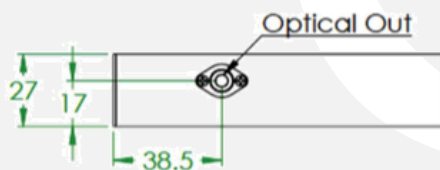
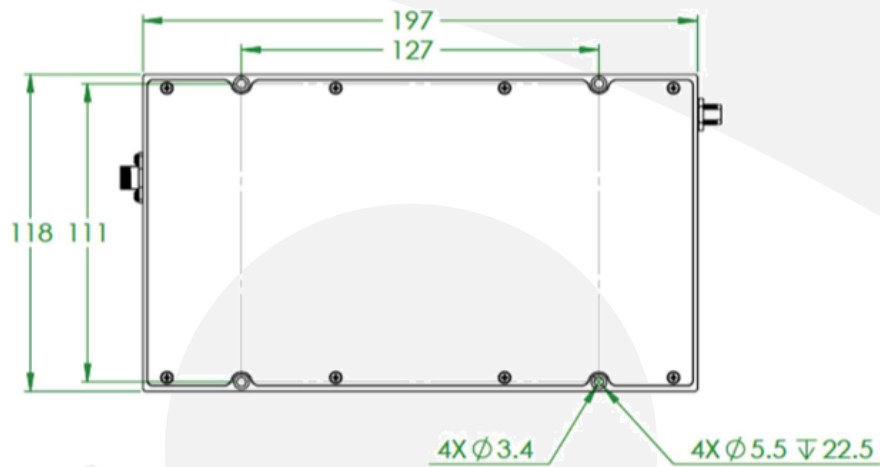

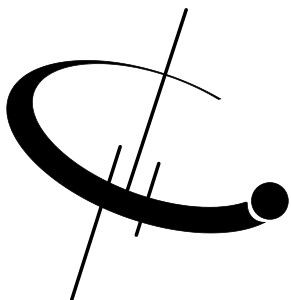

# LTA-40

## PRECISION POWER SUPPLY FOR LTA (OPTIONAL)

FRONT



BACK



General Specifications	
Parameters	Specifications
Input AC Voltage (VAC)	85-240
Input AC Current (A)	≤0.5
Input AC Frequency (HZ)	50-60
Transfer Efficiency	≤85%
DC Output Current (A)	4 A max.
DC Output Voltage (V)	±5 V
DC Voltage Ripple	≤2%
DC Connectors	Molex 4 Pin
Communication Connectors	DB-9 and USB 2.0
Dimensions (mm)	153x115x33

## TYPICAL S21 AND S11 BANDWIDTH FOR LD VERSION

