

MD-20-M



DEVICE

20 GHz Modulator Driver with Adjustable Gain

OVERVIEW

The Optilab MD-20-M Modulator Driver (MD) is a 20 GHz Bandwidth RF Amplifier in a compact and user-friendly module that provides a high-quality, single-ended voltage to drive an optical modulator. Typical applications include driving EML, EAM, and Mach-Zehnder devices, and it can also be used as a wideband RF amplifier with useable bandwidth of up to 20 GHz, including its adjustable output up to 21.5 dBm, making it suitable for many RF link applications. The MD-20-M amplifies 20 Gb/s data input signals to >7.5 Vp-p drive levels, and the flat gain and group delay response yield a high quality, low-jitter electrical drive signal for digital applications. Featuring a single +12V DC power supply, this versatile module also has an anodized, precision-machined aluminum housing designed for efficient heat dissipation during prolonged use. In addition to its amplification function, the MD-20-M also features a manually adjustable DC bias output voltage port, to further complement its effectiveness when used with a standard optical modulator. The MD-20-M also supports diplexed RF + DC port configurations for full optical modulator compatibility. Contact Optilab for more information.

FEATURES

- Optional diplexed DC input port
- Variable Gain Control via USB
- Built in heat sink
- Bandwidth from 0.1 to 20 GHz
- Output power of 21.5 dBm
- Manual DC bias output port to 10 volt

USE IN

- 20 GHz Analog RFoF link
- Amplified RF signals to 20 GHz
- General laboratory test and measurement
- 20 Gb/s digital modulation

FUNCTIONAL DIAGRAM

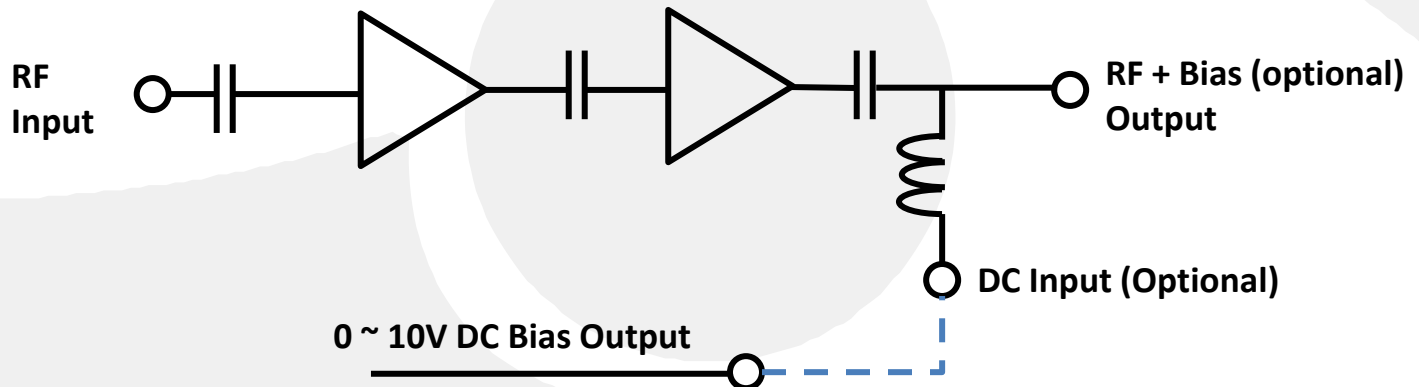

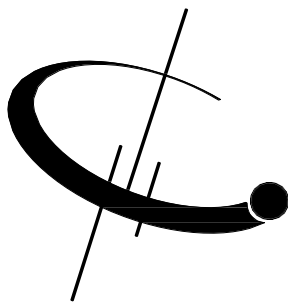

MD-20-M

SPECIFICATIONS

3 dB S21 Bandwidth	16 GHz min., 18 GHz typical
Low Cutoff Frequency	30 kHz typical, 60 kHz max.
Small Signal Gain @ 1 GHz	22 dB min., 23 dB typical

GENERAL

Input 1 dB Compression Point	0 dBm typical
Gain Adjustment Range	≥ 7 dB
Saturation Output Power	20.8 dBm min., 21.5 dBm typical
S11 Characteristics	< -10 dB from 100 MHz to 15 GHz < -5 dB from 15 GHz to 20 GHz
S22 Characteristics	< -10 dB from 100 MHz to 12 GHz < -5 dB from 12 GHz to 20 GHz
Input, Output Impedance	50 Ω
Manual DC Bias Adjustment Range	0 to +10 V typical

ANALOG APPLICATIONS

Useable RF Bandwidth	20 GHz typical
Input IP3	+ 12 dBm typical
Noise Figure	9 dB typical

DIGITAL APPLICATIONS

Data Rate	Up to 20 Gb/s
Output Amplitude	Up to 7.5 Vpp
Input Amplitude	0.5Vpp to 1.5Vpp

MECHANICAL

Operating Temperature	-10 °C to +50 °C
Storage Temperature	-25 °C to +70 °C
Power Supply Requirements	+12V, 1.5 A max
Total Power Dissipation	10 W
Accessories Included	4-Pin Molex Power Cable, USB Cable
RF Input Connector	SMA female
RF Output Connector	SMA male
Remote Interface	USB
Dimensions	160 mm x 65mm x 32.5 mm



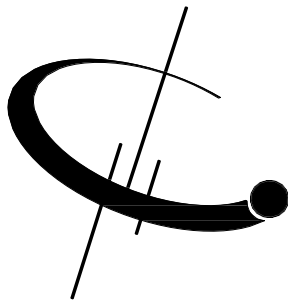

MD-20-M

TYPICAL S21 RESPONSE

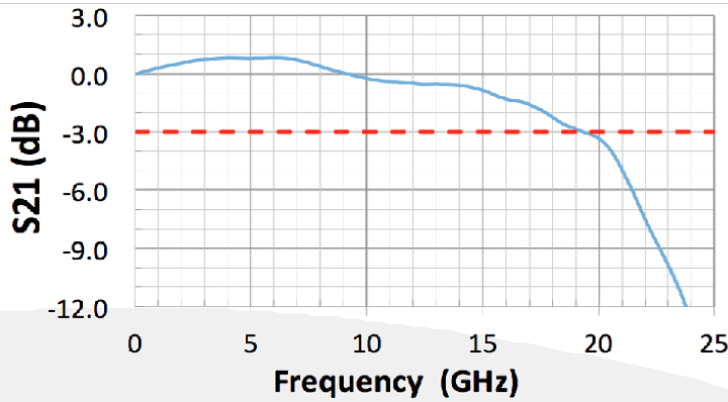

TYPICAL S11 RESPONSE

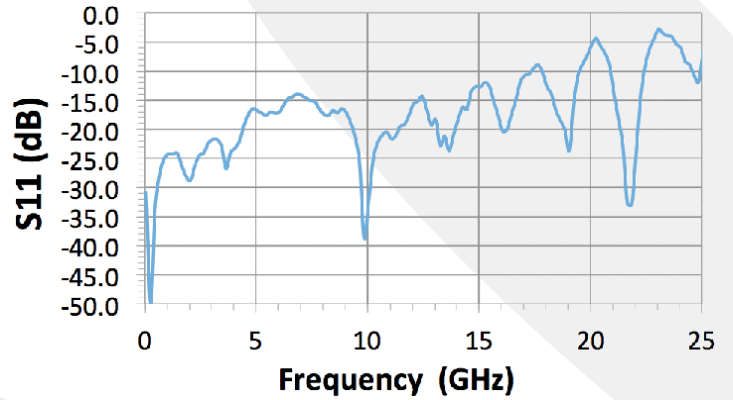

1 DB COMPRESSION

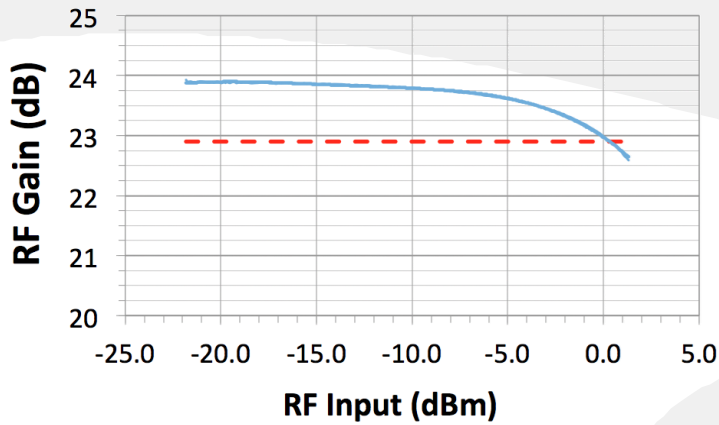

THIRD ORDER INTERCEPT

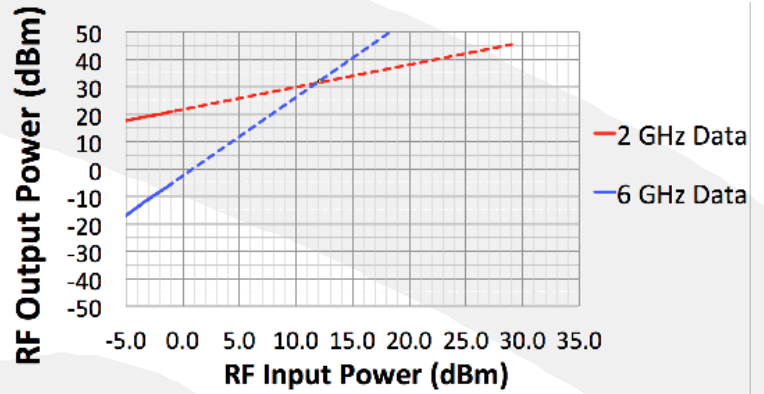

GROUP DELAY

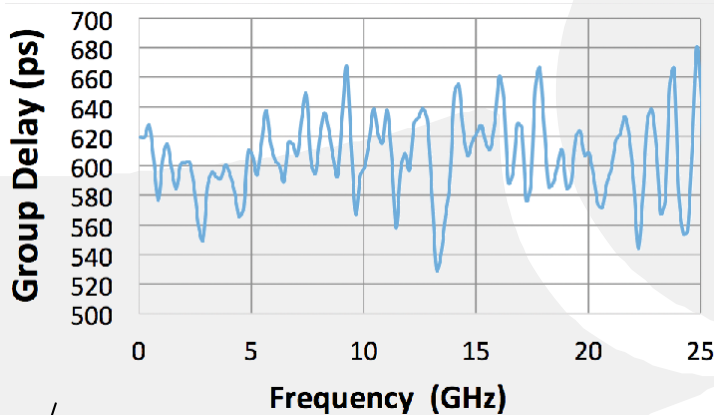

NOISE FIGURE

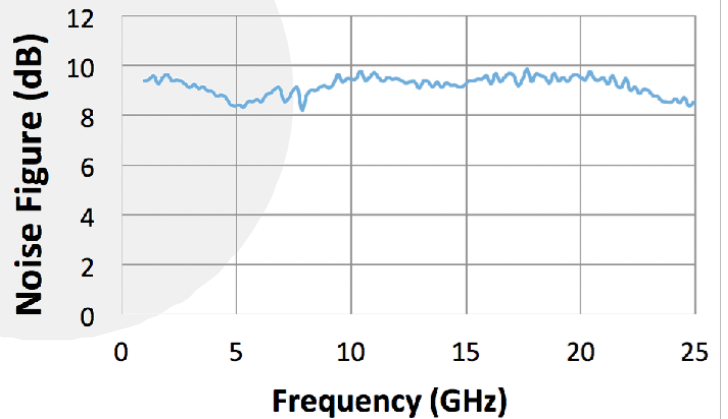

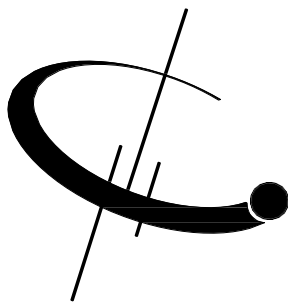

MD-20-M

MECHANICAL DRAWING

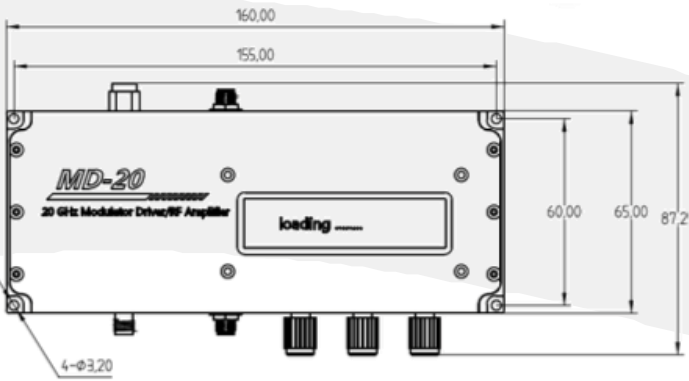
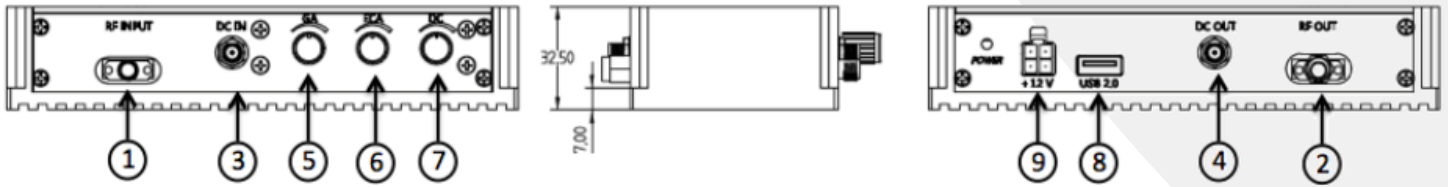

Unit: mm

Port Function Description

Port Number	Function Description
1	RF input
2	RF output
3	DC bias input
4	DC bias output
5	RF gain adjust knob
6	Eye crossing adjust knob
7	DC output adjust knob
8	USB 2.0
9	Power input molex

APPLICATION DIAGRAM

