

Optimize the performance
of **high-power** laser processes

High-power beam shapers for laser beam welding, laser cutting, additive manufacturing and surface processing

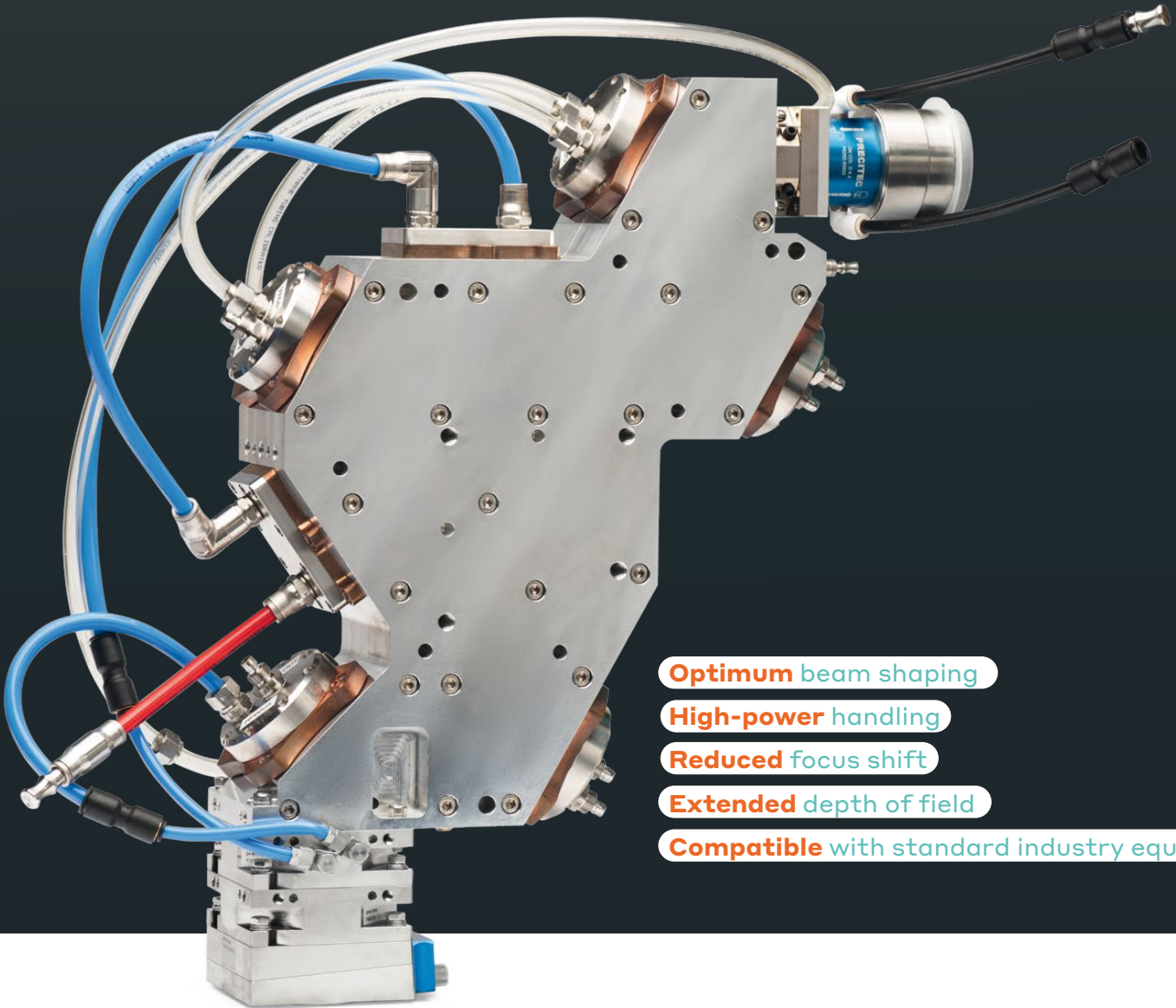

Optimum beam shaping

High-power handling

Reduced focus shift

Extended depth of field

Compatible with standard industry equipment

CANUNDA-HP offers modules and laser heads that enable all kinds of beam shaping to improve the quality and efficiency of high-power laser processes.

The **CANUNDA-HP** beam shaping modules can be used to shape **high-power continuous lasers**. They can perform several shaping: a **ring** or a **rectangle** in standard versions, or any **symmetrical** (e.g. ring with a central spot...) or **asymmetrical** (e.g. spot followed by a line...) profile on demand.

The **fully reflective design** of the shaping module supports very high average power (16 kW demonstrated in partnership with the Institut Maupertuis). It can be cooled in a homogeneous manner for optimal results, thus **minimizing the thermal focus shift**.

CANUNDA-HP modules have been **integrated in industrial environments** with optical fiber lasers on robot arms. The shaping module can either be fitted directly to the laser connector and integrate the entire optical chain up to the machining plane, or it can be integrated into standard, off-the-shelf collimation and focusing optical instruments, such as additive manufacturing machines.

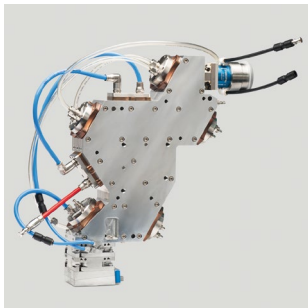

CANUNDA-HP
ring shaper
(p. 3-5)

CANUNDA-HP ring shaper produces a high-quality **annular beam shape** addressing **laser beam welding** applications.

Benefits:

- High depth of field
- Reduced focus shift



CANUNDA-HP
top-hat shaper
(p. 6-8)

CANUNDA-HP Top-Hat Shaper delivers a **rectangular beam shape** with **tunable factory-set dimensions**, addressing all **high-power surface treatment** applications.

Benefits:

- High homogeneity
- Reduced mass and bulk

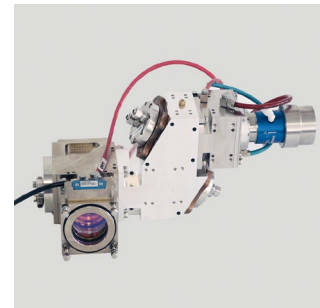

CANUNDA-HP
custom shaper
(p. 9)

A custom CANUNDA-HP system can be designed to generate **any required shape** (symmetrical or asymmetrical) on demand.

Benefits:

- Tailored solution
- Adaptable to any environment

Integration

in an industrial environment

1 **LLK-D connector**

2 **Collimation mirror**
water cooled

3 **Shaping mirror**
water cooled

4 **Focusing mirror**
water cooled

5 **Protective window**

6 **Cross-Jet**

7 **Robot**

A **Collimation unit**

B **Shaping unit**

C **Focusing unit**

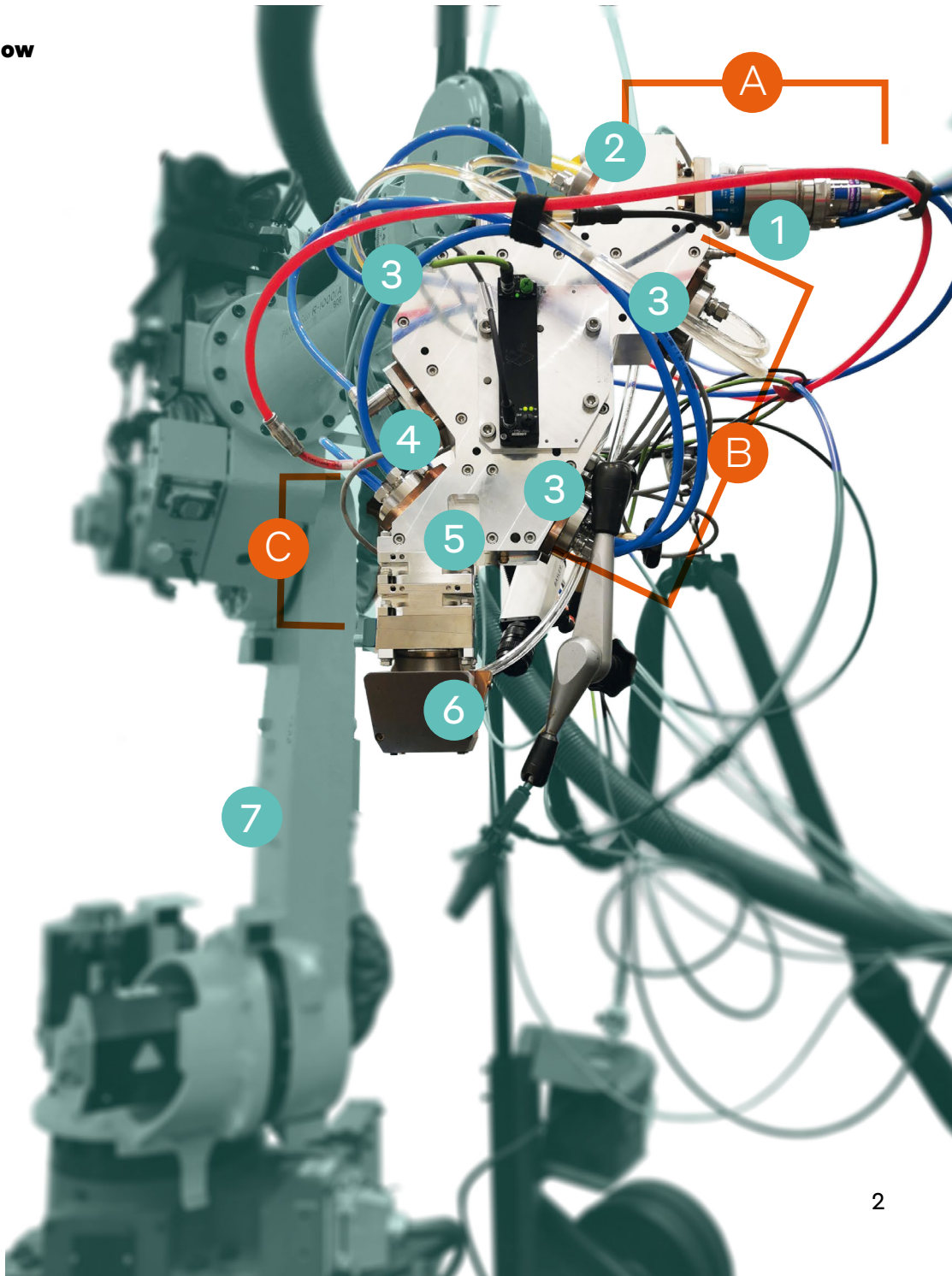

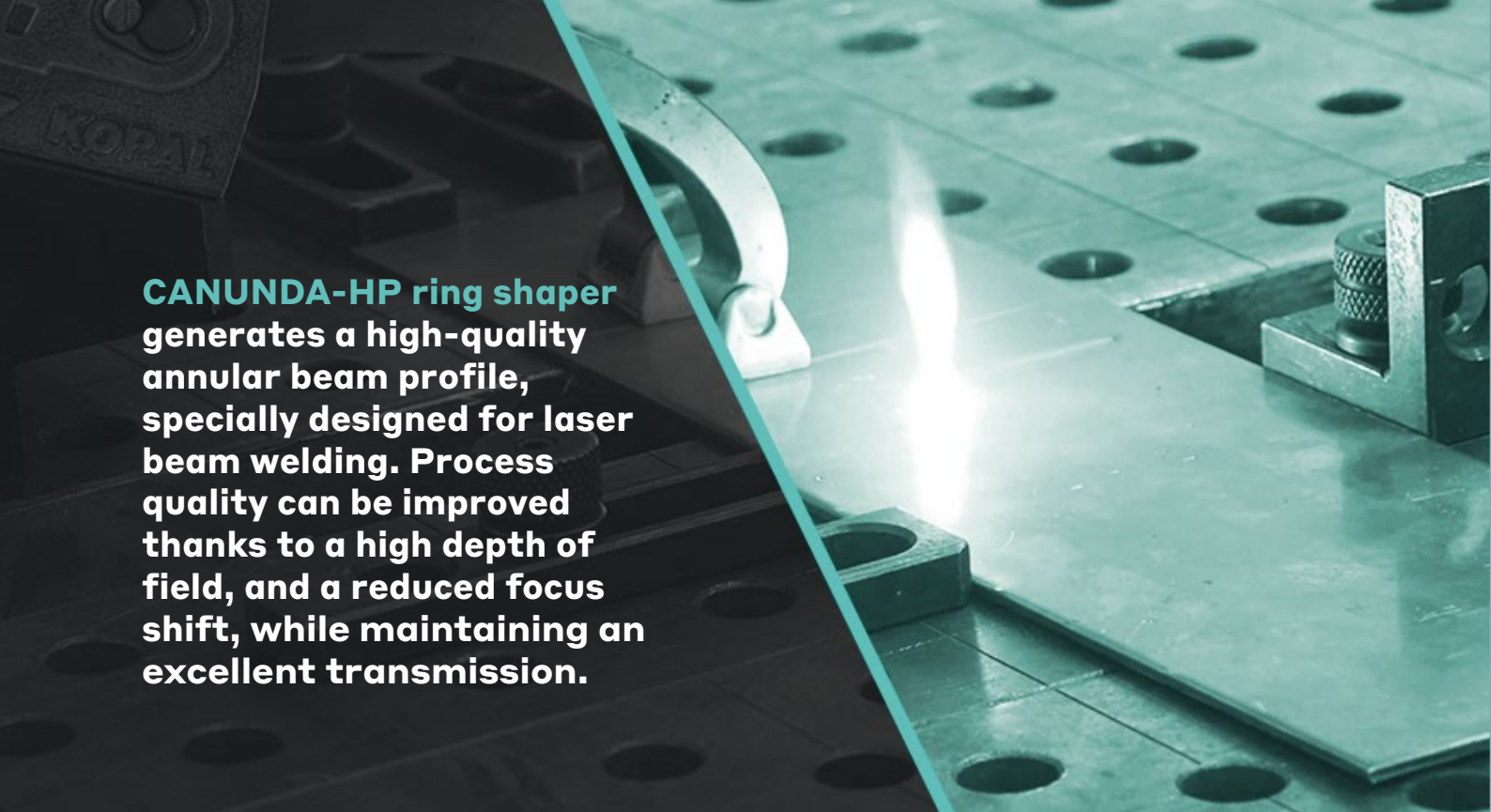

CANUNDA-HP ring shaper generates a high-quality annular beam profile, specially designed for laser beam welding. Process quality can be improved thanks to a high depth of field, and a reduced focus shift, while maintaining an excellent transmission.

CANUNDA-HP *for* laser beam welding

Optimum beam shaping

- 800 µm ring diameter 200 µm ring width
- **High homogeneity** up to 7%
- **Preserved BPP**
- **High depth of field** of +/- 3 mm

High-power handling

- **Fully reflective** system enabling optimal cooling
- Stable operation **up to 16 kW**
- **Focus shift highly reduced** to 1 mm
- **High transmission** superior to 99%

Standard industry equipment compatibility

- 335 mm x 450 mm x 74 mm system weighting only 15 kg
- **Standard LLK-D or QBH connexions** to the laser
- Output compatible with industry Cross-Jet
- **Compatible with multiple lasers:** Trumpf, IPG, Coherent...
- Laser head **adapted to any industry robot**

For a ready-to-use system

- **Quick installation: no alignment needed**
- Add-ons available for a quick alignment before the process (on-axis camera, alignment laser pen...)
- Add-ons available to ease the process (welding monitoring side camera, protective gaz, Wire Arc Laser Welding...)
- Add-ons available to monitor the process (temperature, diffused light captor...)

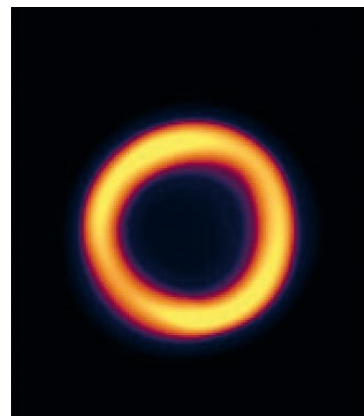

Standard ring shaping of CANUNDA-HP

CANUNDA-HP ring beam shaper specifications

PARAMETER	UNIT	SPECIFICATION
Shape characteristics		
Shape	-	Annular
Diameter ⁽¹⁾	µm	800 typical
Width ⁽¹⁾	µm	200 typical
Depth of field	mm	6
Homogeneity (along the ring)	% RMS	Max 7, typical 5
System characteristics		
Transmission	%	99
Weight ⁽²⁾	kg	15
Dimensions ⁽²⁾	mm x mm x mm	335 x 450 x 74
Integration in an industry environment		
Coolant flow (min)	L/min	2
Chiller cooling capacity (min) ⁽³⁾	kW	1
Input Connector	-	LLK-D or QBH
Input laser wavelength	nm	1030
Input laser Beam Parameter Product (BPP)	mm.mrad	8 typical
Input laser power (max)	kW	16
Input laser fiber core diameter	µm	100 to 300
Input laser fiber numerical aperture	-	0.07 to 0.2
Output Cross-Jet	-	Compatible with standard industry equipment
Mechanical holding	-	Compatibility with standard industry robots

⁽¹⁾ Exact diameter depends on fiber diameter and laser BPP, provided on request

⁽²⁾ LLK-D connector included, Cross-Jet included, add-ons excluded

⁽³⁾ Cross-Jet excluded

Physical dimensions

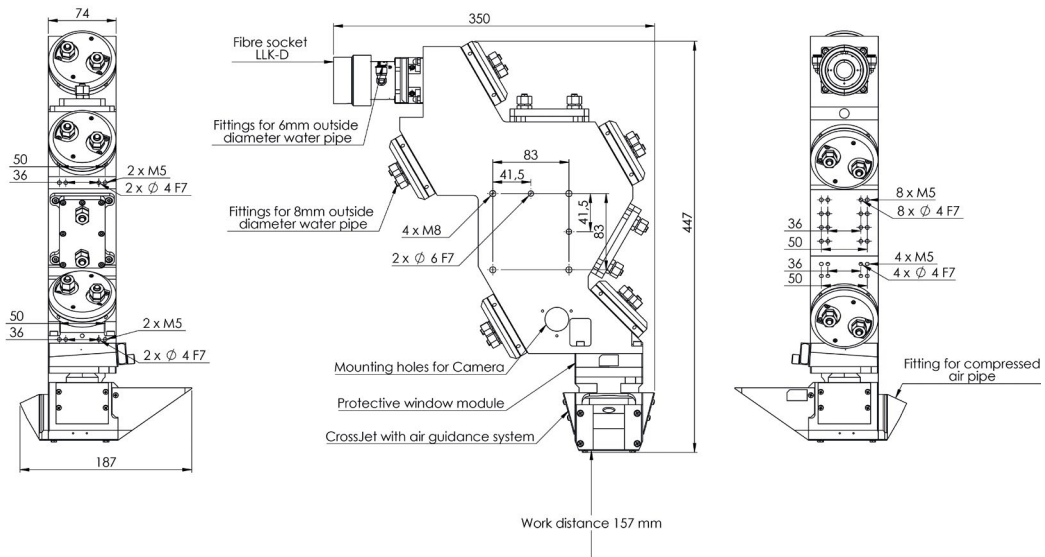

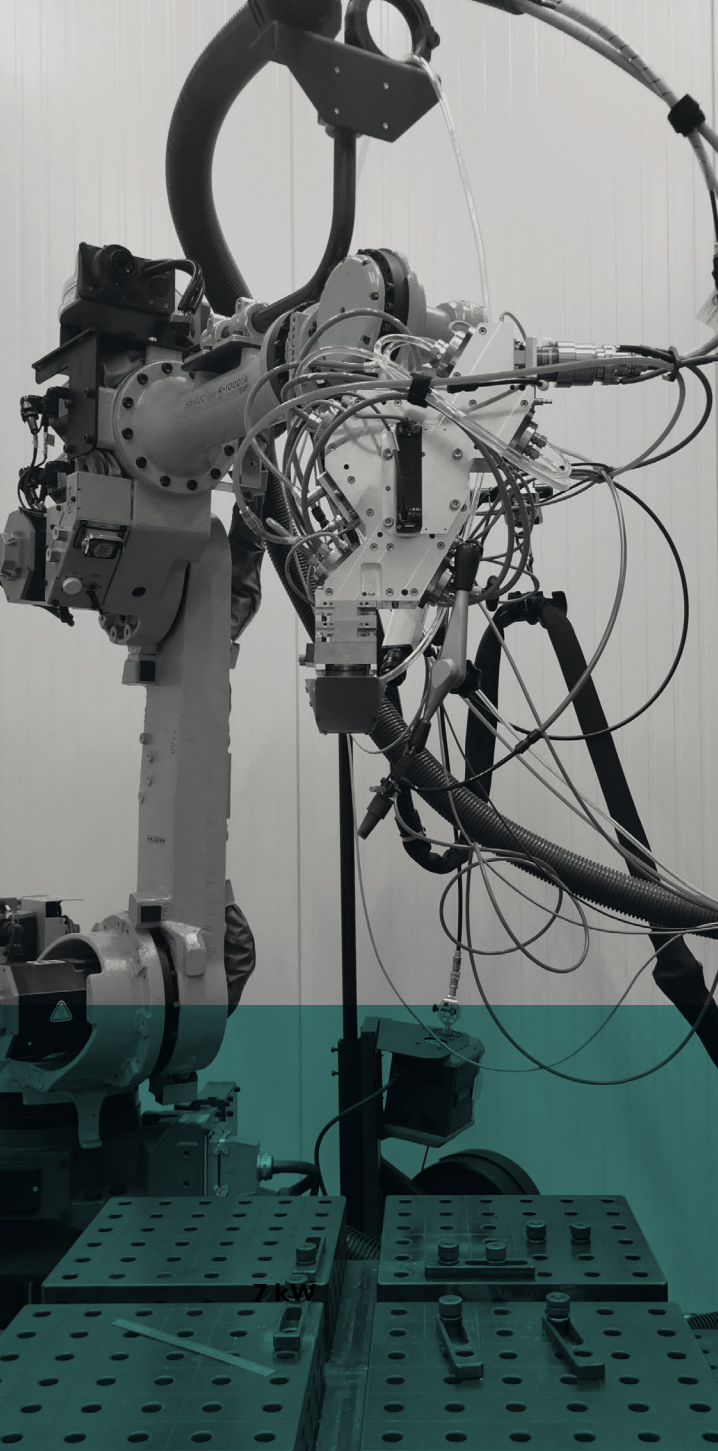

Case study

Laser beam welding demonstrated in partnership with the **Institut Maupertuis**

Institut Maupertuis specializes in high-power laser processes including laser welding and additive manufacturing. It provides its partners with **optimal process solutions**.

The collaboration between Institut Maupertuis and Cailabs aims to develop a beam shaping solution to **improve complex laser welding processes**, especially for thick metal sheets.

For this, it is necessary to withstand very **high power** while ensuring a **stable process** in these extreme conditions. The fully reflective design of Cailabs' solution is of great interest because it allows for optimal cooling of the laser head. It provides a high-quality ring beam shape using Multi-Plane Light Conversion (MPLC), a technology developed by Cailabs.

Once Cailabs developed the laser welding head **CANUNDA-HP**, Institut Maupertuis was able to optimize its laser processes up to **16 kW!** Measurements performed at Institut Maupertuis using a PRIMES and a Beam Watch confirmed the effective stability of the laser head: **the focus shift is reduced** to 1 mm with an **optimum depth of field** of 6 mm. The resulting ring beam shape is well balanced and **provides very good quality weld seam**. The full penetration on a 6 mm thick stainless steel sheet is reached at 7kW.

	Welding seam	Macrograph
at 7 kW		

6 mm stainless steel welding seam on aluminum at 1 m/min with Argon shielding gas

CANUNDA-HP top-hat shaper is a laser head providing a rectangular top-hat beam shaping. With different factory-set beam dimensions available on demand, many processes can be improved, such as Automated Fiber Placement, heat treatment or surface polishing.



CANUNDA-HP *for* surface processing

High homogeneity rectangle

- From 1x5mm² to 40 x 175 mm² flat-top squares or rectangles
- **High homogeneity** down to 6%.
- Very sharp edges

High-power handling

- **Fully reflective** system enabling optimal cooling
- Stable operation **up to 16 kW**
- **High transmission** superior to 99%

Standard industry equipment compatibility

- **Quick installation: no alignment needed**
- **Standard LLK-D or QBH connexions** to the laser
- System design for any high power near infrared CW laser
- Laser head **adapted to any industry robot**

A compact system that fits any mechanical interface

- **Reduced mass and bulk**
- Add-ons available to regulate the process (pyrometer...)
- Add-ons available to ease the process (protective gaz...)
- Possibility to deviate the output beam for a better fitting in your industrial installation

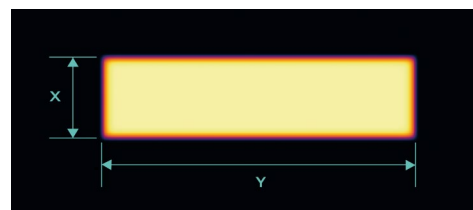

Rectangular top-hat shaping of CANUNDA-HP

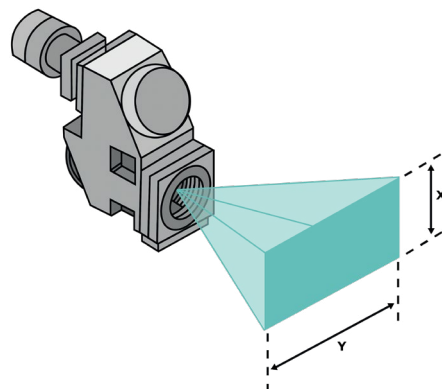

CANUNDA-HP top-hat beam shaper specifications

PARAMETER	UNIT	SPECIFICATION
Shape Characteristics		
Shape	-	Top-hat rectangle
X dimension	mm	From 1 to 40
Y dimension	mm	From 5 to 175
Homogeneity	% ptv	+/- 5 typ. +/- 10 max
System characteristics		
Transmission	%	99
Weight	kg	4.5 ⁽¹⁾
Dimensions	mm x mm x mm	218x186x74 ⁽¹⁾
Output beam deviation angle	-	On request ⁽²⁾
Working distance	mm	200 – 600 ⁽²⁾
Integration in an industrial environment		
Input laser power (max)	kW	16
Input laser wavelength	nm	980 – 1080
Input laser Beam Parameter Product (BPP)	mm.rad	Compatible with any high power near infrared CW laser
Input laser fiber numerical aperture	-	<0.2
Input connector	-	LLK-D or QBH
Coolant flow (min)	L/min	2
Chiller cooling capacity (min) ⁽³⁾	kW	1

⁽¹⁾ More compact design available on demand

⁽²⁾ Available range depends on the selected parameters (shape dimensions, maximum power, working distance)

⁽³⁾ Independent chiller from the laser

Physical dimensions

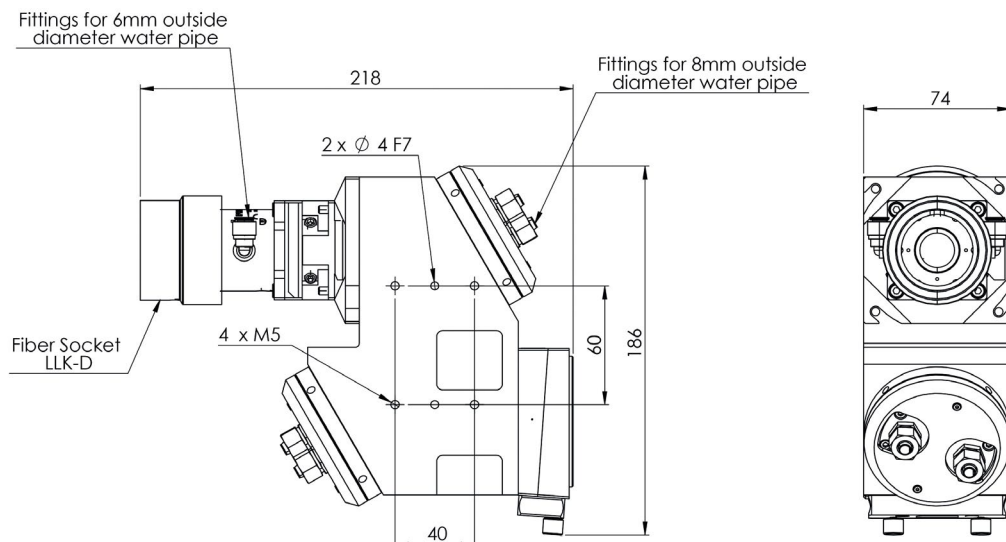

Case study

Laser heating of composite tape in Automated Fiber Placement (AFP) processes with **Coriolis Composites**

Coriolis Composites is a French company specializing in Automated Fiber Placement processes. This technique is used to **manufacture composite parts** via robotic automation. It consists of tapes of fiber successively heated and deposited on a mold.

Coriolis decided to avail of **Cailabs'** expertise in laser beam shaping to produce a **rectangular top-hat** beam fitting the dimensions of the composite tapes. The head needed to be ultra-compact in order to produce highly curved parts and to group multiple heads side-by-side to place several tapes of composite fibers independently.

It is important to have good quality beam shaping, i.e. with a **homogeneous intensity and sharp beam edge**. The tape is heated selectively and uniformly; the heat does not affect the machine tool parts or the surrounding tapes already deposited. Furthermore, the beam shaping system must be able to be **integrated on a robotic arm**, resulting in weight and space constraints.

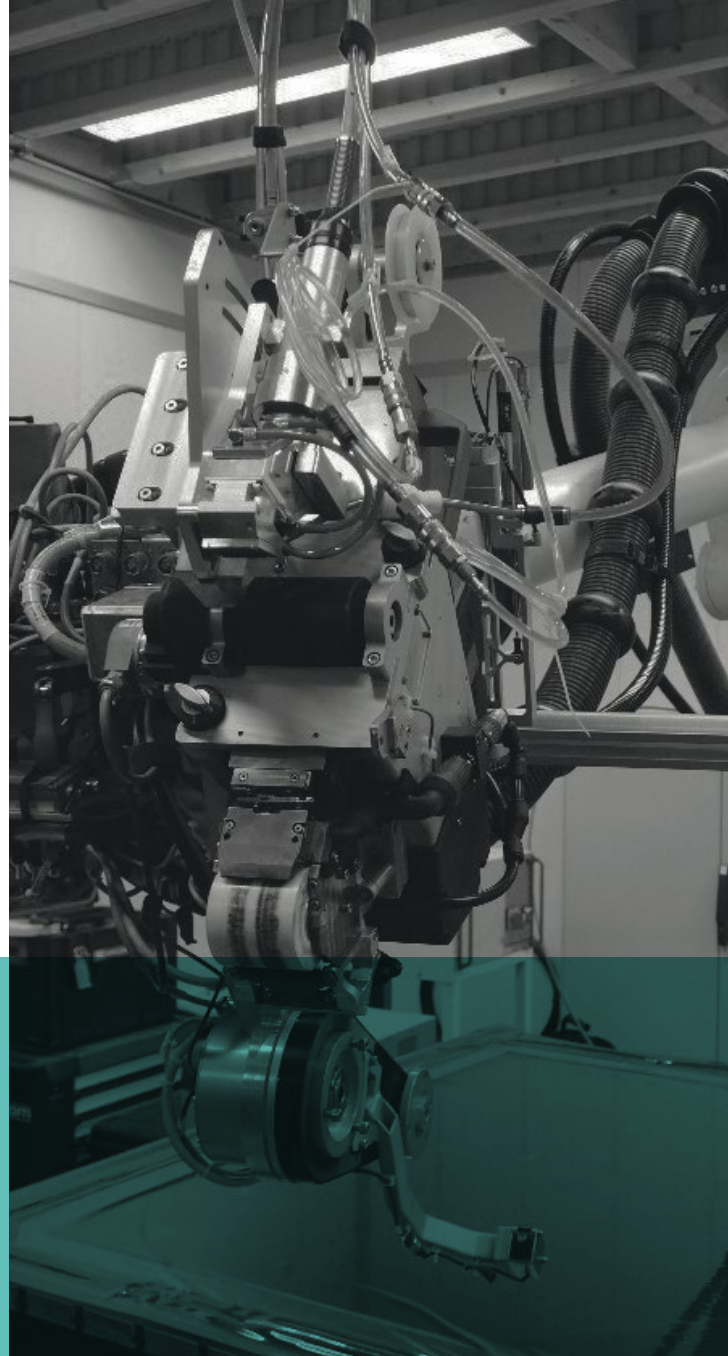

A **CANUNDA-HP** head was developed to satisfy these requirements. It was designed to be **easily integrated into industrial environments** while producing a high-quality beam, thus **providing improved draping quality** with an ensured adhesion and cohesion between the layers. The head is ultra-compact, allowing it to drape new deeply curved parts and multiple fibers independently. Finally, **CANUNDA-HP** can handle the high power of continuous-wave lasers, thanks to its integrated cooling system.

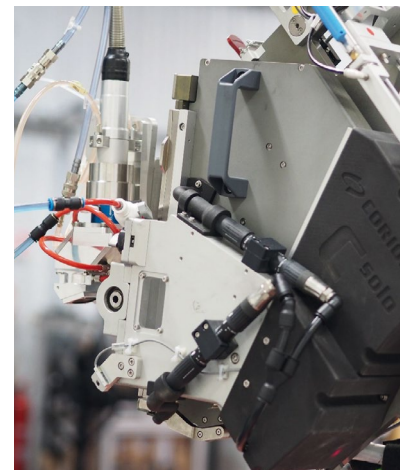
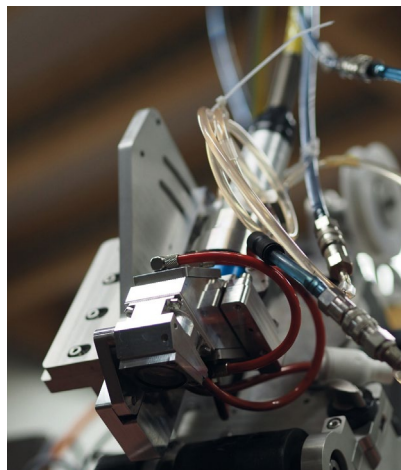
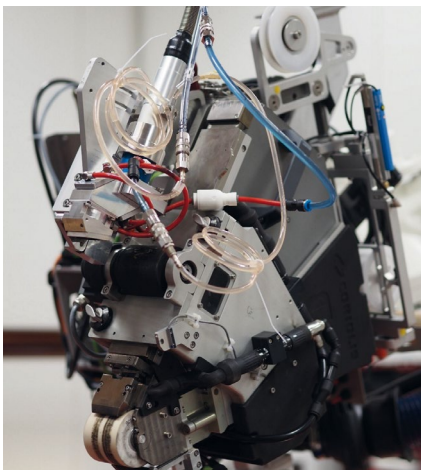

Custom CANUNDA-HP systems can be designed on demand. Cailabs develops tailored solutions to shape any required beam profile, adaptable on specific environment and laser sources.



Custom CANUNDA-HP systems *available* on demand

Cailabs can develop beam shaping systems to suit your needs:

- Custom adaptation of the input laser: the beam shaping system can integrate lasers with various core diameters and numerical apertures, as well as all types of laser technology
- Custom beam shaping: complex beam shaping can be achieved with Cailabs' MPLC technology, such as separate or asymmetrical shapes, or small or large top-hat profiles
- Adaptation to all environments: it is possible to develop compatible beam shaping systems for all your machines, including galvanometer scanners

Benefits of laser beam shaping

High-power multimode laser beam shaping improves performance of many applications

Laser beam welding

- 95-98% of defects elimination
- 70% of lead-time decrease
- 20% cost reduction

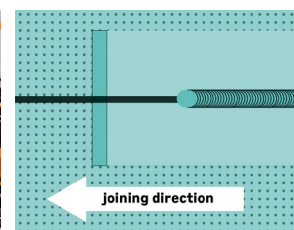

Laser beam cutting

- 100% cutting speed increase
- 50% lead-time decrease
- 20% cost reduction

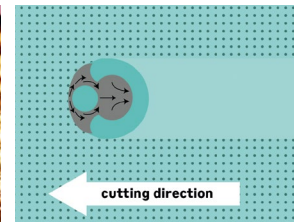

Additive manufacturing

- 40% weight lost
- 83% of lead-time decrease
- 60% cost reduction

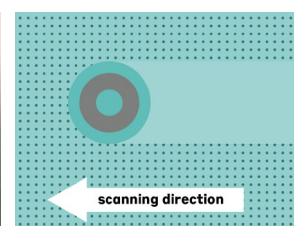

CANUNDA-HP main applications

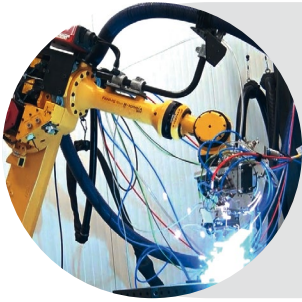

Laser beam welding

Currently, the challenge for laser welding is to improve the reproducibility and reliability of processes. This requires a very stable keyhole, which is possible to achieve by **optimizing the energy input on the workpiece using beam shaping such as the one provided by CANUNDA-HP.**

Laser cutting

The main challenge for laser cutting is to improve output by **increasing cutting speeds and reducing the number of poor quality parts produced**, which is made possible with CANUNDA-HP.



Additive manufacturing

The main challenge for additive manufacturing, also known as 3D printing, is producing parts requiring no post-processing at a higher speed. **CANUNDA-HP provides the beam shaping modules compatible with 3D-printing machines** that makes it possible.

Automated Fiber Placement

For the purposes of increasing production yield, heating the tape is a critical parameter that limits draping speed and affects the quality of the composite part. **CANUNDA-HP provides homogeneous, high-power heating to meet this requirement, and its ultra-compact head makes it possible to drape deeply curved parts.**

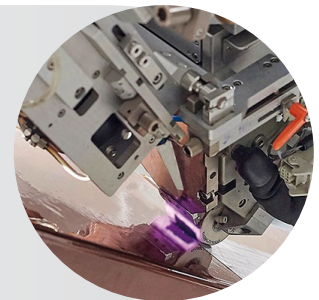

Laser heat treatment

The requirement for selective, high-quality and high-yield processing is a challenge for laser heat treatment processes such as quenching, tempering and softening of metal parts. **With CANUNDA-HP, these processes can be performed homogeneously with controlled overlap when scanning the parts.**

Find out about all our CANUNDA solutions

The CANUNDA product line aims at improving all types of laser processes:

- **High-power continuous** laser processes such as laser beam welding or additive manufacturing with CANUNDA-HP
- **Ultra-short pulsed** processes such as micro-machining, glass processing or surface texturing with:

CANUNDA PULSE

CANUNDA-PULSE for top-hat generation and laser beam stabilization

CANUNDA SPLIT

CANUNDA-SPLIT for beam division

CANUNDA AXICON

CANUNDA-AXICON for Bessel beams

All CANUNDA products are providing a high quality beam shaping and a compatibility to any industrial environment!

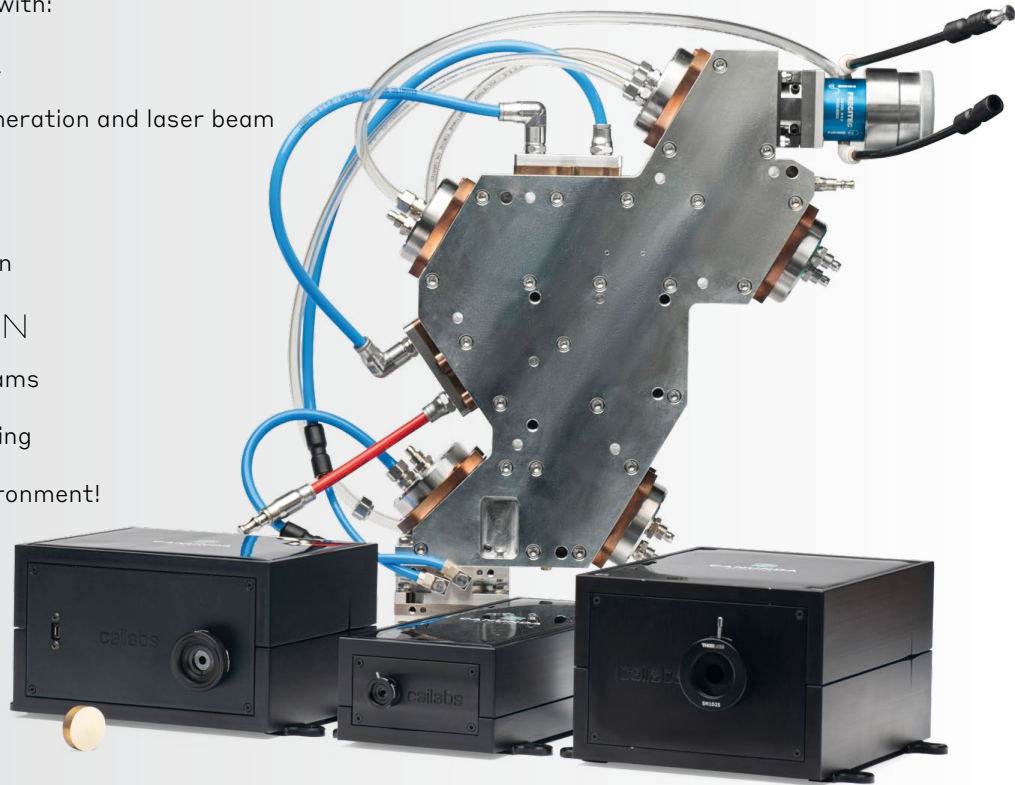

Ordering information

The **CANUNDA-HP ring shaper** is available off-the-shelf with the following ordering information:

Product number: **CAHP-R-001-1030**

- CAHP: CANUNDA-HP
- X-YYY: shape information
 - R: ring shape
 - 001: providing a 600 μm inner 1 mm outer diameter ring
 - Other dimensions coming soon
- WWWW: central wavelength 1030 nm

The **CANUNDA-HP top-hat shaper** is configurable (upon validation from Cailabs) with the following information:

Product number: **CAHP-T-A-ZZZ-1030**

- CAHP: CANUNDA-HP
- X-Y-ZZZ: shape information
 - T: rectangular top-hat shape
 - Y: mechanical configuration
 - ZZZ: setting of configurable parameters
- WWWW: central wavelength 1030 nm

Customized systems are available on demand, contact us to get a quotation!

cailabs

SHAPING THE LIGHT

Founded in 2013, **Cailabs** is a French deep tech company which designs, manufactures and distributes innovative photonic products for telecommunications, free space transmission, industrial lasers, and LANs. A global leader in complex light shaping, its technology is currently protected by 19 patent families. Its innovative optical components are used in a variety of sectors and have contributed to several world records (notably the optical fiber bandwidth record achieved by the Japanese operator KDDI).

38 boulevard Albert 1er
35200 Rennes, France

www.cailabs.com
canunda@cailabs.com

 @CAILabs