

COMB-1300-25-PM-32-OI Preliminary

25GHz Comb-Laser, Fiber Coupled Module



Features:

- 25 GHz channel spacing
- more than 32 channels at recommended operation point
- more than 70 channels possible for higher bias voltage
- frequency modulated mode locking (no pulses)
- low individual relative intensity noise (RIN)
- build-in optical isolator

Applications:

- O-band WDM signal source

Recommended Operating Conditions

at CW, the case is mounted on room temperature heatsink

Parameter	Min.	Typ.	Max.	Unit
Chip Temperature	20	25	30	°C
LD Forward Current		500	600	mA
Reverse Bias Voltage	0	2	3	V

Characteristics

only guaranteed under recommended (Typ.) operating conditions: CW, 25C, 500mA, 2V

Parameter	Min.	Typ.	Max.	Unit
Total Optical Power	75	125		mW
Forward Voltage		1.9	2.5	V
Threshold Current		40	50	mA
Mean Wavelength*	1295	1300	1305	nm
Bandwidth (FWHM)	4.5	5		nm
Bandwidth (at -10 dB level)		7		nm
Mode Spacing	24	25	26	GHz
Average Optical Power per Channel**	2	3.5		mW
Number of Channels**	35	37		
Beating Spectrum Linewidth***		200	500	kHz
Individual mode RIN (averaged in DC-10GHz range)		-135	-125	dB/Hz
Polarization Extinction Ratio (PER)	15	20		dB

*can be customized; ** at -3dB level; ***at -20dB level

Absolute Maximum Ratings

Parameter	Min	Max	Unit
LD Forward Current		800	mA
LD Reverse Voltage		1	V
Reverse Bias Voltage		4	V
Bias Forward Current		60	mA
TEC Current		3	A
TEC Voltage		4	V
Chip Operating Temperature	15	55	°C
Case Operating Temperature	0	70	°C
Pin Soldering Temperature (max 10 sec, max case temperature 85°C)		300	°C
Storage Temperature	-40	85	°C
Fiber Band Radius	3		cm

Typical Performance

unless otherwise stated, measured at CW, 25°C, 500mA, 2V

Total Output Power (L-I)

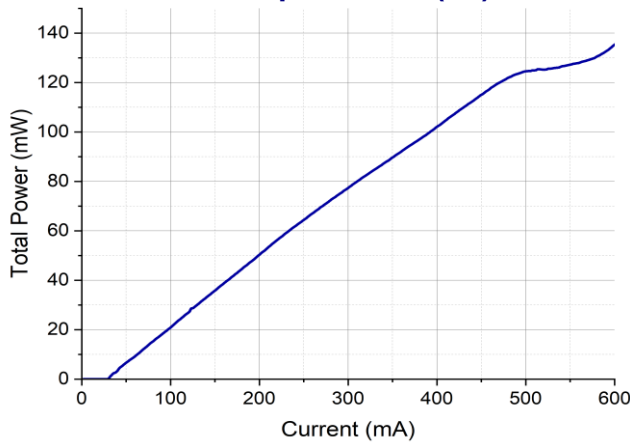

Forward Voltage (I-V)

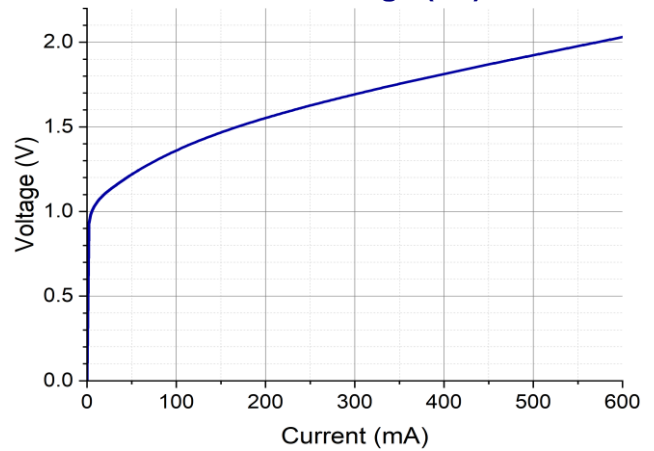

Optical Spectrum (res. 10pm)

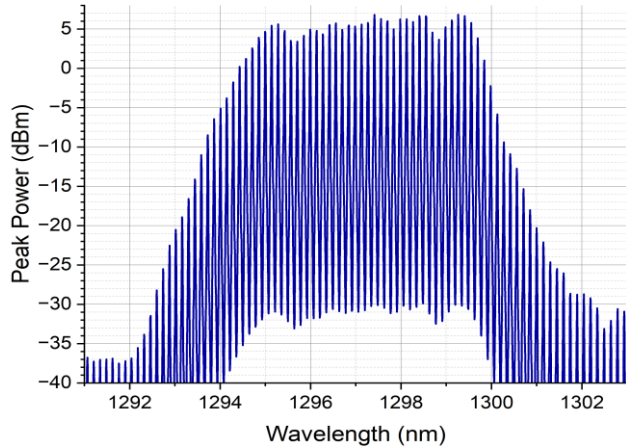

RF spectrum of all beating modes

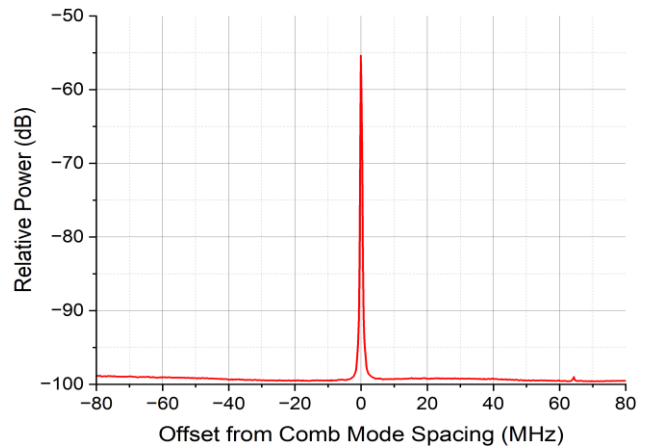

Individual Mode RIN

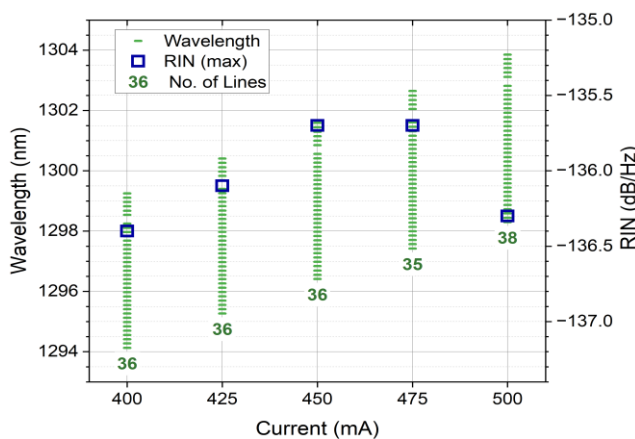

Bias Voltage Dependencies

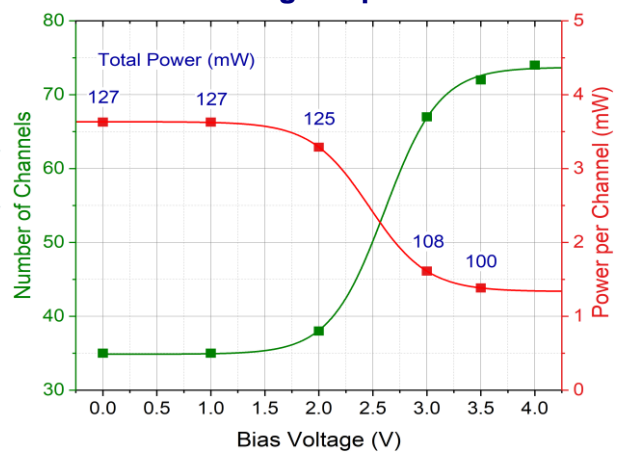

Thermistor specification			Fiber specification		
Parameters	Value	Unit	Parameters	Value	Unit
Type	NTC		Fiber Type	PM1300	
Resistance @ 25°C	10±0.1	kOhm	Numerical Aperture (Typical)	0.12	
Beta 25-85°C	3435±1%	K	Cut-off Wavelength	1200±70	nm
			Mode-Field (core) Diameter	9.3±0.5 @1300nm	µm
			Cladding Diameter	125±1	µm
			Coating (buffer) Diameter	245±15	µm
			Loose Tube Diameter (optional)	900	µm
			Connector	FC/APC	
			Key	narrow	

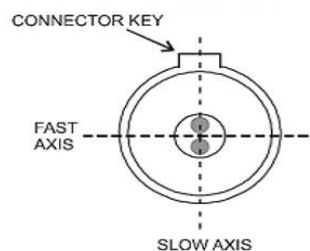
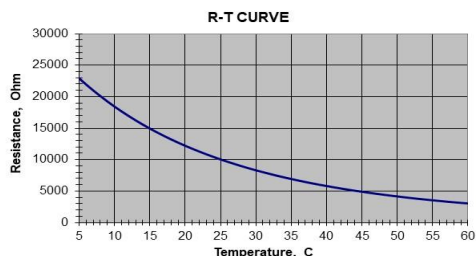

The output light is polarized along the slow axis of PM fiber.

Dimensions (in mm)

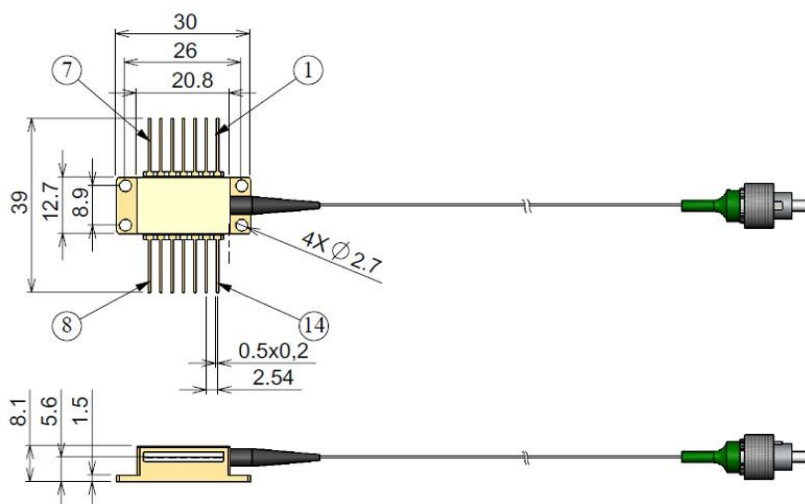

Pin identification:

1. TEC "+"
2. Thermistor
3. -
4. -
5. Thermistor
6. Bias "-"
7. -
8. -
9. Common (LD Cathode "-", Bias "+")
10. LD Anode "+"
11. Common (LD Cathode "-", Bias "+")
12. -
13. Case

Safety and Operating Instructions

The light emitted from this device is invisible and can be harmful to the human eye. Avoid looking directly into the fiber connector when the device is in operation. Proper laser safety eyewear must be worn during operation with open connector. Absolute Maximum Ratings may be applied to the device for short period of time only. Exposure to maximum ratings for extended period of time or exposure to more than one maximum rating may cause damage or affect the reliability of the device. Operating the device outside of its maximum ratings may cause device failure or a safety hazard. Power supplies used with the component must be employed such that the maximum forward current cannot be exceeded.

A proper heatsink for the device on thermal radiator is required. The device must be mounted on radiator with 4 screws (bolt down in X-style fashion with initial torque set to 0.075Nm and final X-style bolt down at 0.15Nm) or with clamps. The deviation from flatness of radiator surface must be less than 0.05mm. It's recommended using of Indium foil or thermal conductive and soft material between bottom of the case and heatsink for thermal interface. It's undesirable to use thermal grease for this. Avoid back reflection to the device. It may give impact on the device performance in aspects of spectrum and power stability. It also may cause fatal facet damage. Using of optical isolators is highly recommended to block back reflection.

Do not pull the fiber. Do not bend a fiber with a radius smaller than 3 cm. Fiber tip should always be protected from any contamination or damage during the process of installation. After removing the dust-preventing cap covered at fiber tip, carefully clean fiber tip by wiping through one direction using optical lens cleaning paper or cotton swab dabbed with Iso-Propanol or Ethyl alcohol. Operate the device with clean fiber connector only.

Electrostatic discharge is the primary cause of unexpected product failure. Take extreme precaution to prevent ESD. During device installation, ESD protection has to be maintained - use wrist straps, grounded work surfaces and rigorous antistatic techniques when handling the product.



NOTE: Innolume product specifications are subject to change without notice