

COMB-1310-50-PM-19-OI Preliminary

50GHz Comb-Laser, Fiber Coupled Module

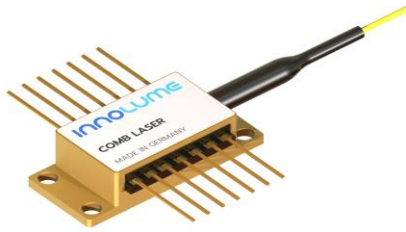

Features:

- 50 GHz channel spacing
- more than 19 channels at recommended operation point
- more than 30 channels possible for higher bias voltage
- frequency modulated mode locking (no pulses)
- low individual relative intensity noise (RIN)
- build-in optical isolator

Applications:

- O-band WDM signal source

Recommended Operating Conditions

at CW, the case is mounted on room temperature heatsink

| Parameter | Min. | Typ. | Max. | Unit |
|----------------------|------|------|------|------|
| Chip Temperature | 20 | 25 | 30 | °C |
| LD Forward Current | | 300 | 400 | mA |
| Reverse Bias Voltage | 0 | 3 | 5 | V |

Characteristics

only guaranteed under recommended (Typ.) operating conditions: CW, 25°C, 300mA, 3V

| Parameter | Min. | Typ. | Max. | Unit |
|--|------|------|------|-------|
| Total Optical Power | 50 | 65 | | mW |
| Forward Voltage | | 2.1 | 2.5 | V |
| Threshold Current | | 30 | 40 | mA |
| Mean Wavelength* | 1305 | 1310 | 1315 | nm |
| Bandwidth (FWHM) | 5.5 | 6 | | nm |
| Bandwidth (at -10 dB level) | 9 | 9.3 | | nm |
| Mode Spacing | 49 | 50 | 51 | GHz |
| Average Optical Power per Channel** | 2 | 3 | | mW |
| Number of Channels** | 21 | 22 | | |
| Beating Spectrum Linewidth*** | | 200 | 400 | kHz |
| Individual mode RIN (averaged in DC-10GHz range) | | -130 | -125 | dB/Hz |
| Polarization Extinction Ratio (PER) | 18 | 21 | | dB |

*can be customized; ** at -3dB level; ***at -20dB level

Absolute Maximum Ratings

| Parameter | Min | Max | Unit |
|---|-----|-----|------|
| LD Forward Current | | 400 | mA |
| LD Reverse Voltage | | 1 | V |
| Reverse Bias Voltage | | 5 | V |
| Bias Forward Current | | 25 | mA |
| TEC Current | | 3 | A |
| TEC Voltage | | 4 | V |
| Chip Operating Temperature | 15 | 55 | °C |
| Case Operating Temperature | 0 | 70 | °C |
| Pin Soldering Temperature (max 10 sec, max case temperature 85°C) | | 300 | °C |
| Storage Temperature | -40 | 85 | °C |
| Fiber Band Radius | 3 | | cm |

Typical Performance

unless otherwise stated, measured at CW, 25°C, 300mA, 3V

Total Output Power (L-I)

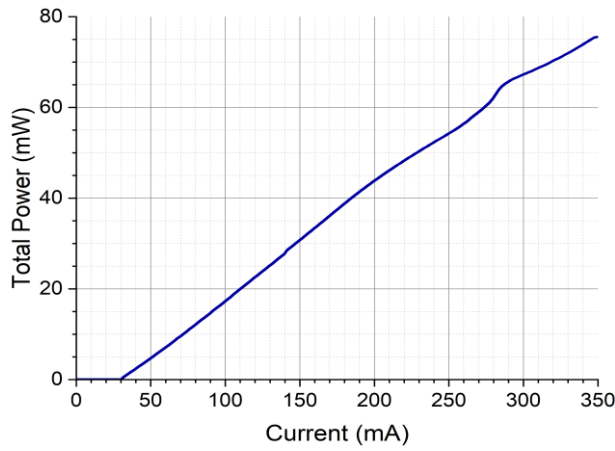

Forward Voltage (I-V)

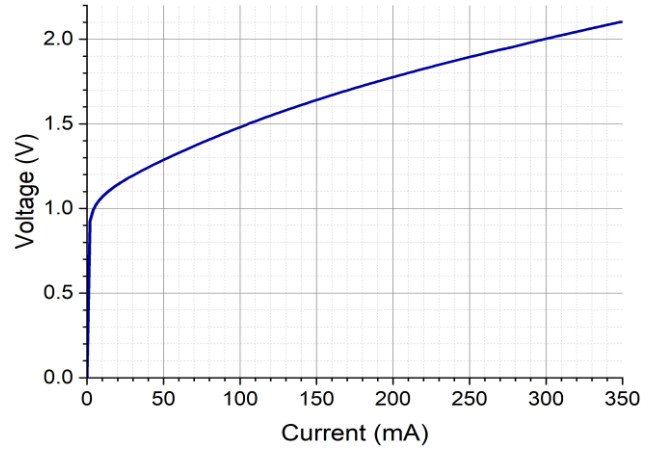

Optical Spectrum (res. 10pm)

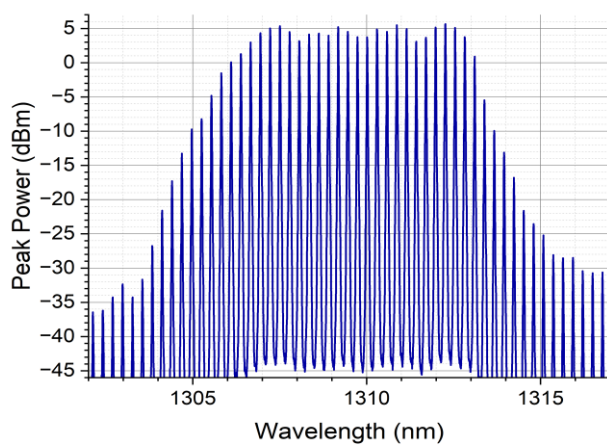

RF spectrum of all beating modes

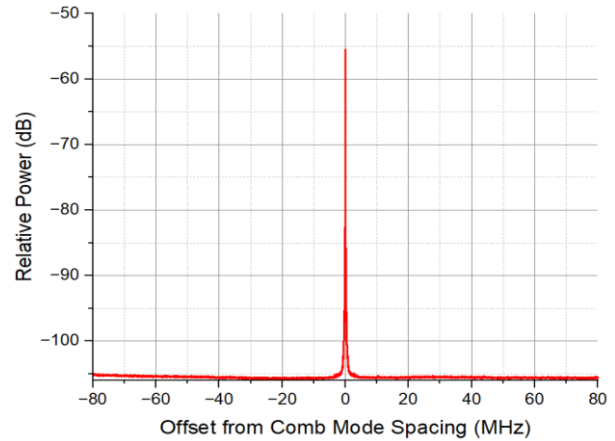

Individual Mode RIN

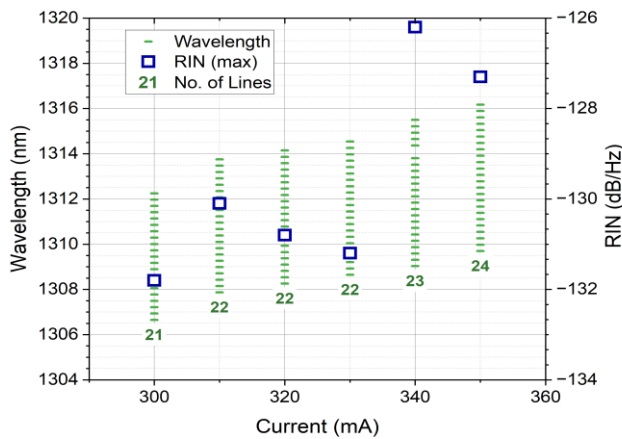

Bias Voltage Dependencies

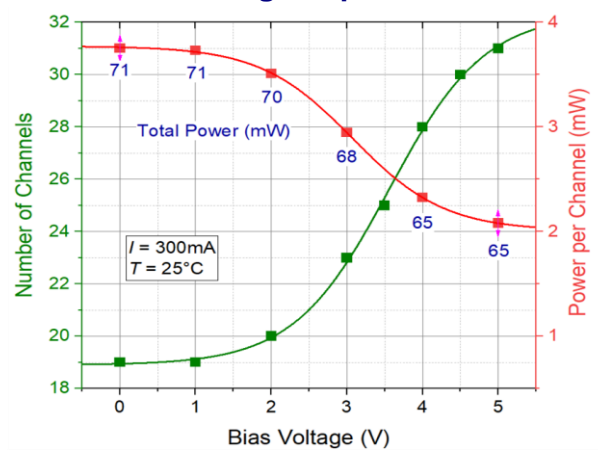

| Thermistor specification | | | Fiber specification | | |
|--------------------------|---------|------|--------------------------------|-----------------|------|
| Parameters | Value | Unit | Parameters | Value | Unit |
| Type | NTC | | Fiber Type | PM1300 | |
| Resistance @ 25°C | 10±0.1 | kOhm | Numerical Aperture (Typical) | 0.12 | |
| Beta 25-85°C | 3435±1% | K | Cut-off Wavelength | 1200±70 | nm |
| | | | Mode-Field (core) Diameter | 9.3±0.5 @1300nm | µm |
| | | | Cladding Diameter | 125±1 | µm |
| | | | Coating (buffer) Diameter | 245±15 | µm |
| | | | Loose Tube Diameter (optional) | 900 | µm |
| | | | Connector | FC/APC | |
| | | | Key | narrow | |

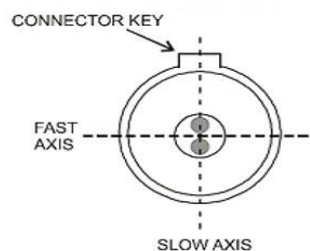
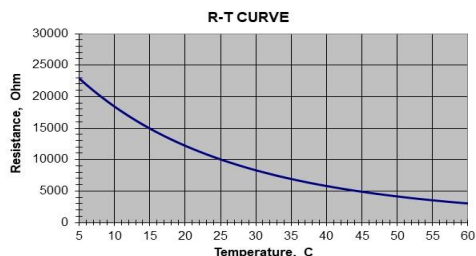

The output light is polarized along the slow axis of PM fiber.

Dimensions (in mm)

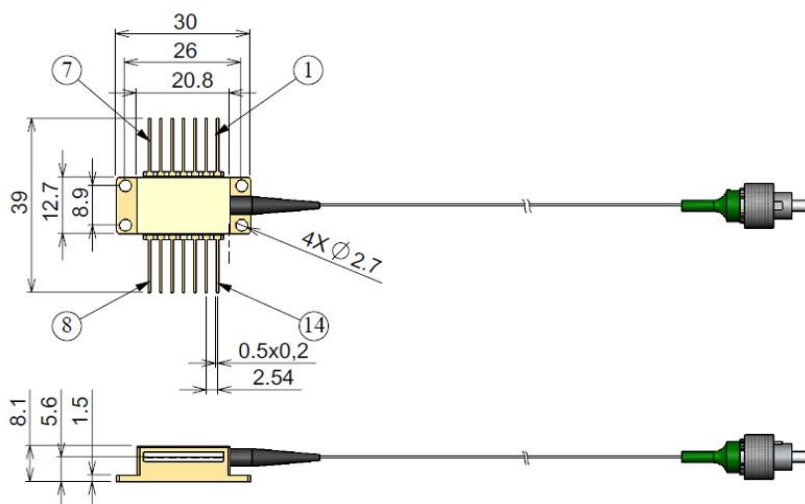

Pin identification:

1. TEC "+"
2. Thermistor
3. -
4. -
5. Thermistor
6. Bias "-"
7. -
8. -
9. Common (LD Cathode "-", Bias "+")
10. LD Anode "+"
11. Common (LD Cathode "-", Bias "+")
12. -
13. Case

Safety and Operating Instructions

The light emitted from this device is invisible and can be harmful to the human eye. Avoid looking directly into the fiber connector when the device is in operation. Proper laser safety eyewear must be worn during operation with open connector. Absolute Maximum Ratings may be applied to the device for short period of time only. Exposure to maximum ratings for extended period of time or exposure to more than one maximum rating may cause damage or affect the reliability of the device. Operating the device outside of its maximum ratings may cause device failure or a safety hazard. Power supplies used with the component must be employed such that the maximum forward current cannot be exceeded.

A proper heatsink for the device on thermal radiator is required. The device must be mounted on radiator with 4 screws (bolt down in X-style fashion with initial torque set to 0.075Nm and final X-style bolt down at 0.15Nm) or with clamps. The deviation from flatness of radiator surface must be less than 0.05mm. It's recommended using of Indium foil or thermal conductive and soft material between bottom of the case and heatsink for thermal interface. It's undesirable to use thermal grease for this. Avoid back reflection to the device. It may give impact on the device performance in aspects of spectrum and power stability. It also may cause fatal facet damage. Using of optical isolators is highly recommended to block back reflection.

Do not pull the fiber. Do not bend a fiber with a radius smaller than 3 cm. Fiber tip should always be protected from any contamination or damage during the process of installation. After removing the dust-preventing cap covered at fiber tip, carefully clean fiber tip by wiping through one direction using optical lens cleaning paper or cotton swab dabbed with Iso-Propanol or Ethyl alcohol. Operate the device with clean fiber connector only.

Electrostatic discharge is the primary cause of unexpected product failure. Take extreme precaution to prevent ESD. During device installation, ESD protection has to be maintained - use wrist straps, grounded work surfaces and rigorous antistatic techniques when handling the product.



NOTE: Innolume product specifications are subject to change without notice