

HL930x Series Baluns (8 MHz to 67 GHz)

Features and Technical Specifications¹ (HL9307 shown)

PRODUCT SUMMARY

The HL930x series are ultra-broadband 180° signal splitters and combiners that offer excellent amplitude and phase match over a bandwidth of 8 MHz to 67 GHz.

The HL930x series is a lower-cost alternative to the HL940x when the lowest low-frequency cutoff is not required.

They are suitable for use in high-speed analog-to-digital conversion, frequency response testing for differential devices, and many other applications.

DEPLOYMENT NOTES

When the device is used as a signal combiner using differential signals with unmatched source impedance, attenuators (3-6 dB) may be required to improve isolation.

If the DC voltage of the balanced or unbalanced ports is non-zero, DC blocks are required. The balanced ports (2 and 3) are DC shorted.

MODELS & OPTIONS

The following models, options are available:

- HL9302**, 26.5 GHz
- HL9304**, 40 GHz
- HL9305**, 50 GHz
- HL9307**, 67 GHz

Bandwidth	8 MHz to 67 GHz
Amplitude Match	± 0.1 dB, f ≤ 50 GHz ± 0.25 dB, f > 50 GHz See Fig. 1
Phase Match	± 4°, f = 20 GHz ± 8°, f = 40 GHz See Fig. 8
Insertion Loss	6 dB, single-ended reference See Figs. 1, 3-4
Return Loss	> 15 dB, unbalanced port, f ≤ 40 GHz > 10 dB, unbalanced port, f > 40 GHz > 10 dB, balanced ports, f ≤ 50 GHz > 7.5 dB, balanced ports, f > 50 GHz See Figs. 2, 5
CMRR	> 25 dB See Fig. 6
Group Delay	≈ 270 ps See Fig. 7
Max Input Power	1 W (+30 dBm)
Connectors	1.85 mm, 3x jack/female 1.85 mm plug connectors upon request
Temperature Limits	-40° to +100° C, operating
RoHS Compliant	Yes, assembled with lead-free solder
REACH Compliant	Yes
Warranty	1 year, see website

NOTE 1 - Unless otherwise noted, the specifications in this table are typical for Model Number HL9307. Full specifications for this and related models are available on Page 2 of this datasheet.



HL9307, standard configuration shown

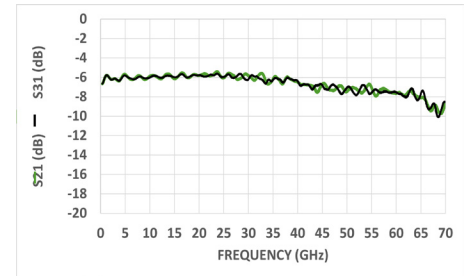

Typical HL9307 Single-ended Insertion Loss

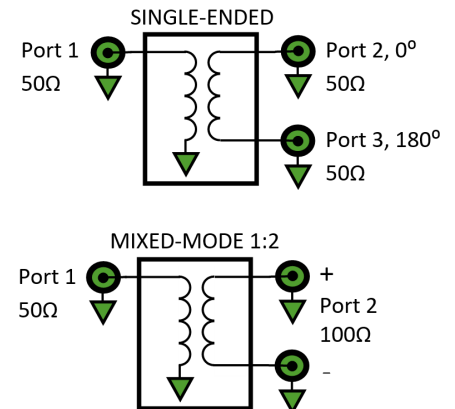

HL930x Schematic and Port Assignments

HL930x Full Specifications

Parameter	HL9302	HL9304	HL9305	HL9307	Comments
Upper Frequency Limit	26.5 GHz	40 GHz	50 GHz	67 GHz	3 dB roll-off point, relative to nominal insertion loss
Lower Frequency Limit	8 MHz	8 MHz	8 MHz	8 MHz	3 dB roll-off point
Amplitude Match <i>See Fig. 1</i>	± 0.1 dB	± 0.1 dB	± 0.1 dB	± 0.1 dB, f ≤ 50 GHz ± 0.25 dB, f > 50 GHz	
Phase Match <i>See Fig. 8</i>	± 4°, f = 20 GHz	± 4°, f = 20 GHz	± 4°, f = 20 GHz ± 8°, f = 40 GHz	± 4°, f = 20 GHz ± 8°, f = 40 GHz	
Insertion Loss <i>See Figs. 1, 3-4</i>	6 dB				Single-ended reference
Return Loss <i>See Figs. 2, 5</i>	> 15 dB, unbal. port > 10 dB, bal. ports	> 15 dB, f ≤ 30 GHz, unbal. port > 12.5 dB, f > 30 GHz, unbal. port, > 10 dB, bal. ports	> 20 dB, f ≤ 30 GHz, unbal. port > 15 dB, f > 30 GHz, unbal. port > 10 dB, bal. ports	> 15 dB, f ≤ 40 GHz, unbal. port > 10 dB, f > 40 GHz, unbal. port > 10 dB, f ≤ 50 GHz, bal. ports > 7.5 dB, f > 50 GHz, bal. ports	unbal. = unbalanced bal. = balanced
Rise Time	13 ps	9 ps	7 ps	5 ps	
CMRR <i>See Fig. 6</i>	> 30 dB, f ≤ 20 GHz	> 30 dB, f ≤ 20 GHz > 25 dB, f > 20 GHz	> 30 dB, f ≤ 25 GHz > 25 dB, f > 25 GHz	> 30 dB, f ≤ 25 GHz > 25 dB, f > 25 GHz	Typical
Group Delay <i>See Fig. 7</i>	≈ 290 ps	≈ 280 ps	≈ 270 ps	≈ 270 ps	
Max Input Power	1 W (+30 dBm)				
Impedance	50 Ω				Input and Outputs
Connectors	SMA, 3x jack/female SMA plug connectors upon request	2.92 mm, 3x jack/female 2.92 mm plug connectors upon request	2.4 mm, 3x jack/female 2.4 mm plug connectors upon request	1.85 mm, 3x jack/female 1.85 mm plug connectors upon request	
Dimensions (W x D x H)	2.25" x 1.50" x 0.55" 57.2 x 38.1 x 14 mm	2.25" x 1.50" x 0.55" 57.2 x 38.1 x 14 mm	2.35" x 1.50" x 0.55" 59.7 x 38.1 x 14 mm	2.39" x 1.50" x 0.55" 60.8 x 38.1 x 14 mm	Package including connectors
Weight	45.3 g (1.6 oz.)				
Operating Temp.	-40° to +100° C				Case temperature
RoHS Compliant	Yes, assembled with lead-free solder				
REACH Compliant	Yes				
Warranty	1 year, repair or replacement; see website for details				

HL9307 Plot Diagrams

Figures 1-6 show the typical S-parameter characteristics for both single-ended and mixed-mode (differential) measurements. Other models show similar performance within their respective specified bandwidths.

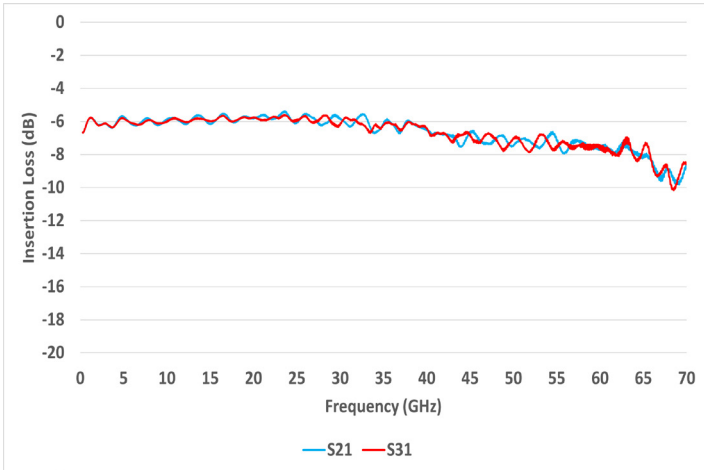

Figure 1: HL9307 Single-ended Insertion Loss

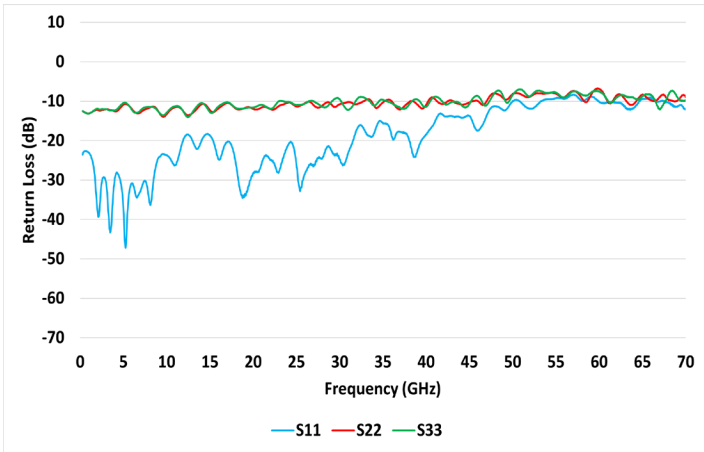

Figure 2: HL9307 Single-ended Return Loss

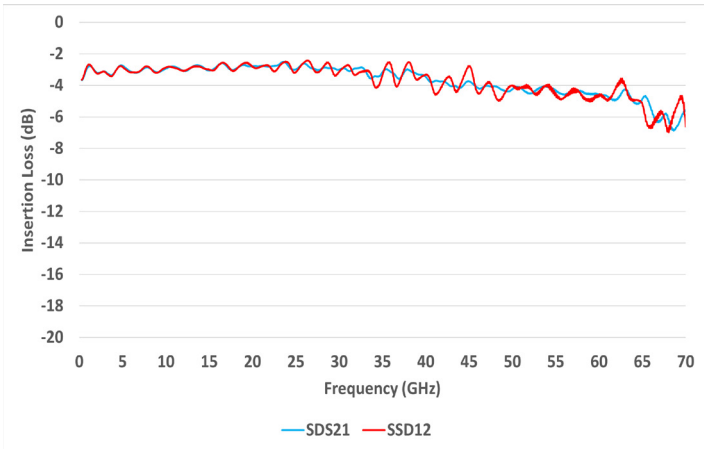

Figure 3: HL9307 Differential Mode Insertion Loss

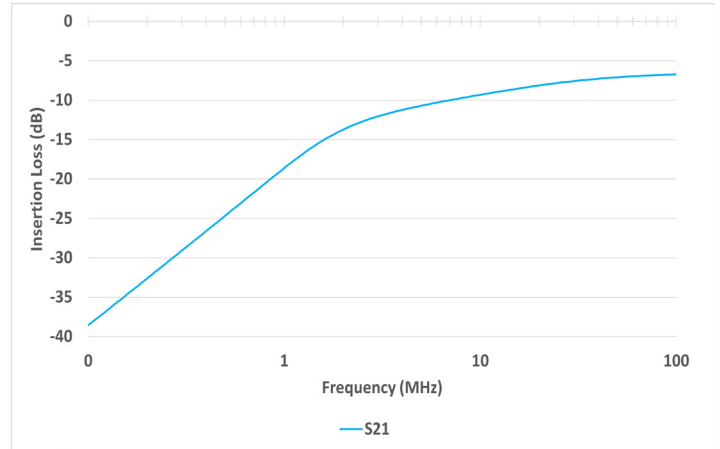

Figure 4: HL9307 Low Frequency Single-ended Insertion Loss

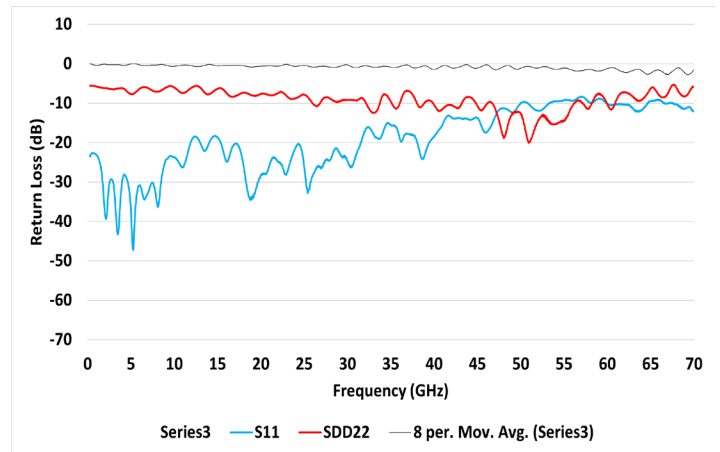

Figure 5: HL9307 Mixed-mode Return Loss

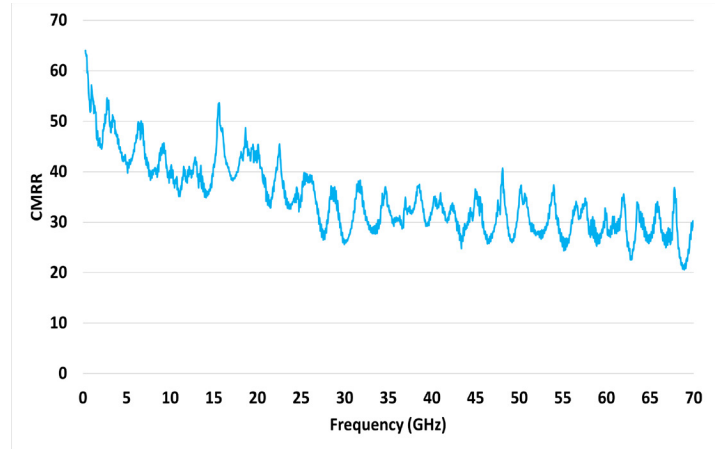

Figure 6: HL9307 Common Mode Rejection Ratio

HL9307 Plot Diagrams (continued)

Figures 7 and 8 show the Group Delay and Phase Mismatch of the HL9307. Other models show similar performance within their respective specified bandwidths.

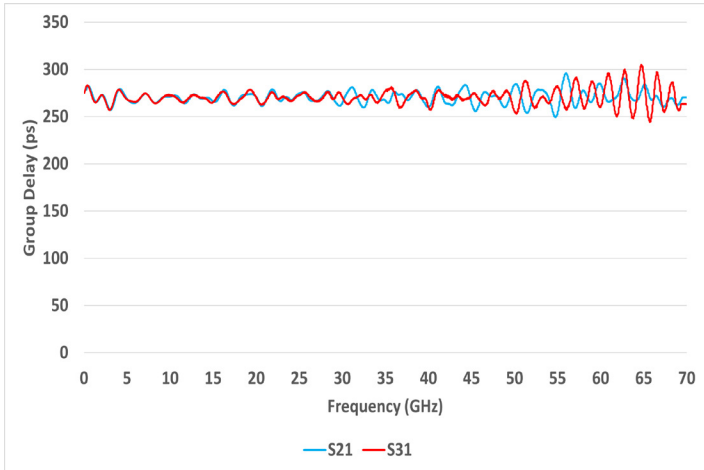

Figure 7: HL9307 Single-ended Group Delay

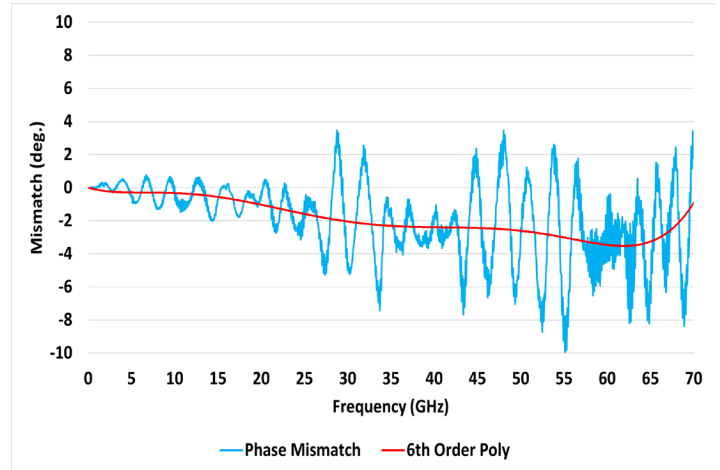

Figure 8: HL9307 Phase Mismatch

HL930x Dimensional Drawing

Figure 9 shows a mechanical drawing of an HL9307. Unless otherwise noted, all units are in inches. Other models vary in width based on connectors.

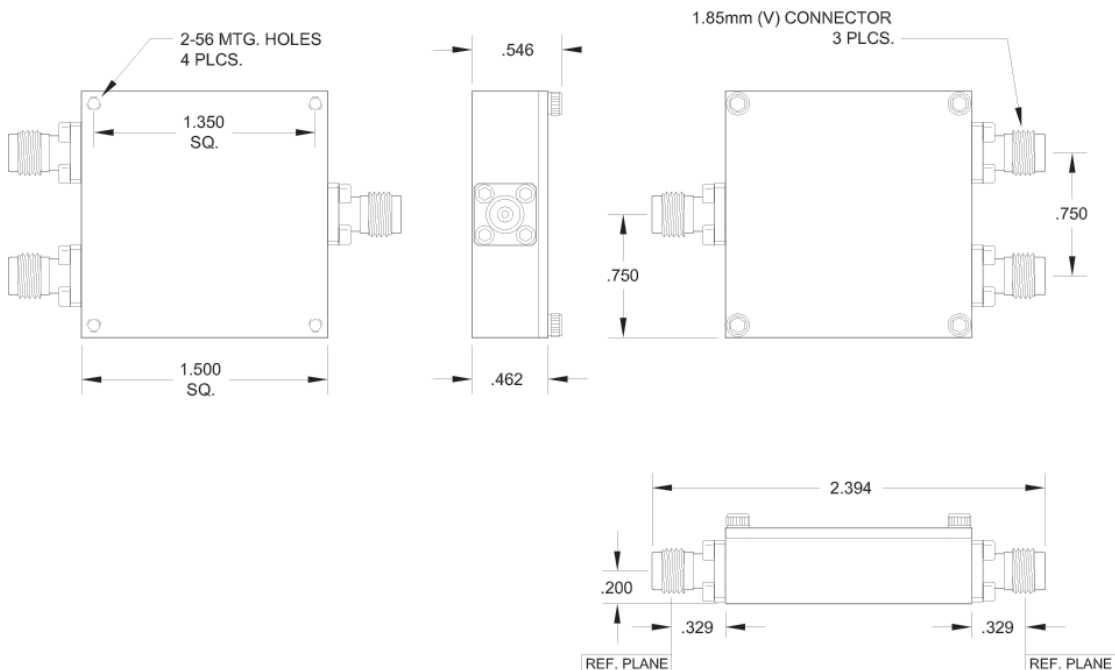

Fig. 9: HL9307 Mechanical Drawing