

HL940x Series Baluns (500 kHz to 67 GHz)

Features and Technical Specifications¹ (HL9407 shown)

PRODUCT SUMMARY

The HL940x series are ultra-broadband 180° signal splitters and combiners that offer excellent amplitude and phase match over an industry-best bandwidth of 500 kHz to 67 GHz.

They are suitable for use in 112 Gbps PAM4 communications systems, high-speed analog-to-digital conversion, frequency response testing for differential devices, and many other applications.

DEPLOYMENT NOTES

When the device is used as a signal combiner using differential signals with unmatched source impedance, attenuators (3-6 dB) may be required to improve isolation.

If the DC voltage of the balanced or unbalanced ports is non-zero, DC blocks are required. The balanced ports (2 and 3) are DC shorted.

MODELS & OPTIONS

The following models, options are available:

- HL9402**, 26.5 GHz
- HL9404**, 40 GHz
- HL9405**, 50 GHz
- HL9407**, 67 GHz

Bandwidth	500 kHz to 67 GHz
Amplitude Match	± 0.1 dB, $f \leq 50$ GHz ± 0.25 dB, $f > 50$ GHz See Fig. 1
Phase Match	$\pm 4^\circ$, $f = 20$ GHz $\pm 8^\circ$, $f = 40$ GHz See Fig. 8
Insertion Loss	6 dB, single-ended reference See Figs. 1, 3-4
Return Loss	> 15 dB, unbalanced port, $f \leq 40$ GHz > 10 dB, unbalanced port, $f > 40$ GHz > 10 dB, balanced ports, $f \leq 50$ GHz > 7.5 dB, balanced ports, $f > 50$ GHz See Figs. 2, 5
CMRR	> 25 dB See Fig. 6
Group Delay	≈ 270 ps See Fig. 7
Max Input Power	1 W (+30 dBm)
Connectors	1.85 mm, 3x jack/female 1.85 mm plug connectors upon request
Temperature Limits	-40° to +100° C, operating
RoHS Compliant	Yes, assembled with lead-free solder
REACH Compliant	Yes
Warranty	1 year, see website

NOTE 1 - Unless otherwise noted, the specifications in this table are typical for Model Number HL9407. Full specifications for this and related models are available on Page 2 of this datasheet.

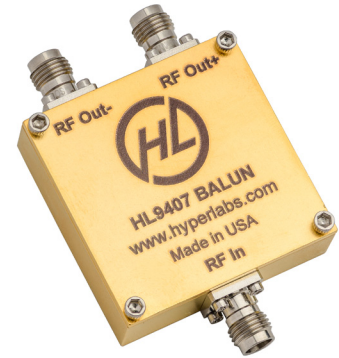

HL9407, standard configuration shown

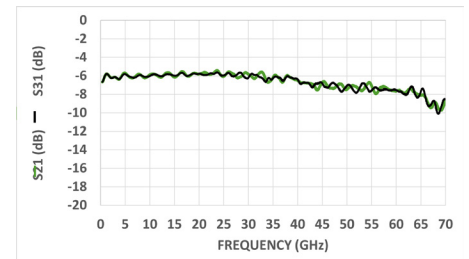

Typical HL9407 Single-ended Insertion Loss

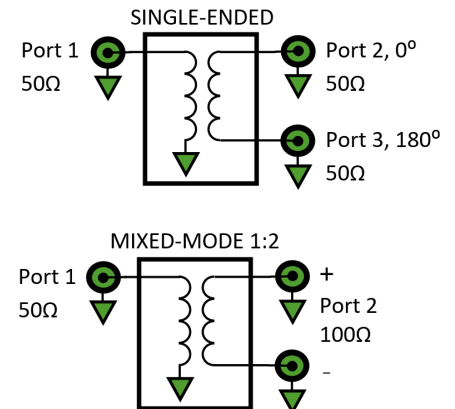

HL940x Schematic and Port Assignments

HL940x Full Specifications

Parameter	HL9402	HL9404	HL9405	HL9407	Comments
Upper Frequency Limit	26.5 GHz	40 GHz	50 GHz	67 GHz	3 dB roll-off point, relative to nominal insertion loss
Lower Frequency Limit	500 kHz	500 kHz	500 kHz	500 kHz	3 dB roll-off point
Amplitude Match <i>See Fig. 1</i>	± 0.1 dB	± 0.1 dB	± 0.1 dB	± 0.1 dB, f ≤ 50 GHz ± 0.25 dB, f > 50 GHz	
Phase Match <i>See Fig. 8</i>	± 4°, f = 20 GHz	± 4°, f = 20 GHz	± 4°, f = 20 GHz ± 8°, f = 40 GHz	± 4°, f = 20 GHz ± 8°, f = 40 GHz	
Insertion Loss <i>See Figs. 1, 3-4</i>	6 dB				Single-ended reference
Return Loss <i>See Figs. 2, 5</i>	> 15 dB, unbal. port > 10 dB, bal. ports	> 15 dB, f ≤ 30 GHz, unbal. port > 12.5 dB, f > 30 GHz, unbal. port, > 10 dB, bal. ports	> 20 dB, f ≤ 30 GHz, unbal. port > 15 dB, f > 30 GHz, unbal. port > 10 dB, bal. ports	> 15 dB, f ≤ 40 GHz, unbal. port > 10 dB, f > 40 GHz, unbal. port > 10 dB, f ≤ 50 GHz, bal. ports > 7.5 dB, f > 50 GHz, bal. ports	unbal. = unbalanced bal. = balanced
Rise Time	13 ps	9 ps	7 ps	5 ps	
CMRR <i>See Fig. 6</i>	> 30 dB, f ≤ 20 GHz	> 30 dB, f ≤ 20 GHz > 25 dB, f > 20 GHz	> 30 dB, f ≤ 25 GHz > 25 dB, f > 25 GHz	> 30 dB, f ≤ 25 GHz > 25 dB, f > 25 GHz	Typical
Group Delay <i>See Fig. 7</i>	≈ 290 ps	≈ 280 ps	≈ 270 ps	≈ 270 ps	
Max Input Power	1 W (+30 dBm)				
Impedance	50 Ω				Input and Outputs
Connectors	SMA, 3x jack/female SMA plug connectors upon request	2.92 mm, 3x jack/female 2.92 mm plug connectors upon request	2.4 mm, 3x jack/female 2.4 mm plug connectors upon request	1.85 mm, 3x jack/female 1.85 mm plug connectors upon request	
Dimensions (W x D x H)	2.25" x 1.50" x 0.55" 57.2 x 38.1 x 14 mm	2.25" x 1.50" x 0.55" 57.2 x 38.1 x 14 mm	2.35" x 1.50" x 0.55" 59.7 x 38.1 x 14 mm	2.33" x 1.50" x 0.55" 59.2 x 38.1 x 14 mm	Package including connectors
Weight	45.3 g (1.6 oz.)				
Operating Temp.	-40° to +100° C				Case temperature
RoHS Compliant	Yes, assembled with lead-free solder				
REACH Compliant	Yes				
Warranty	1 year, repair or replacement; see website for details				

HL940x Single-ended Insertion Loss and Return Loss

Bandwidth for all HYPERLABS baluns is defined as the range of frequencies where insertion loss is within 3 dB of the nominal level (6 dB) in single-ended mode.

Figure 1 shows the insertion loss and amplitude match of an HL9407 in single-ended mode.

Figure 2 shows the return loss of all ports in single-ended mode.

Other models show similar performance within their respective specified bandwidths.

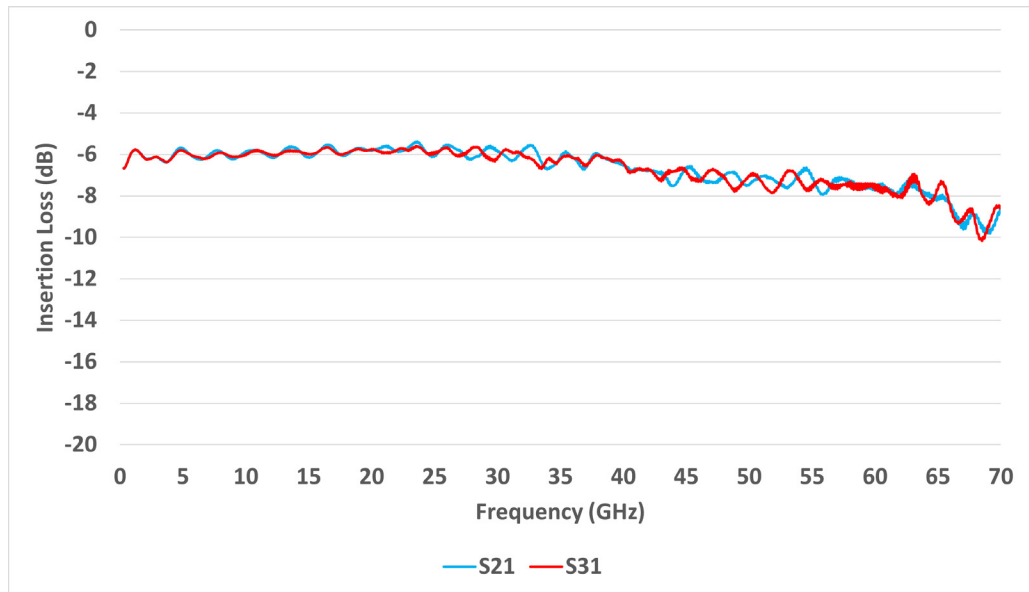

Figure 1: HL9407 Single-ended Insertion Loss

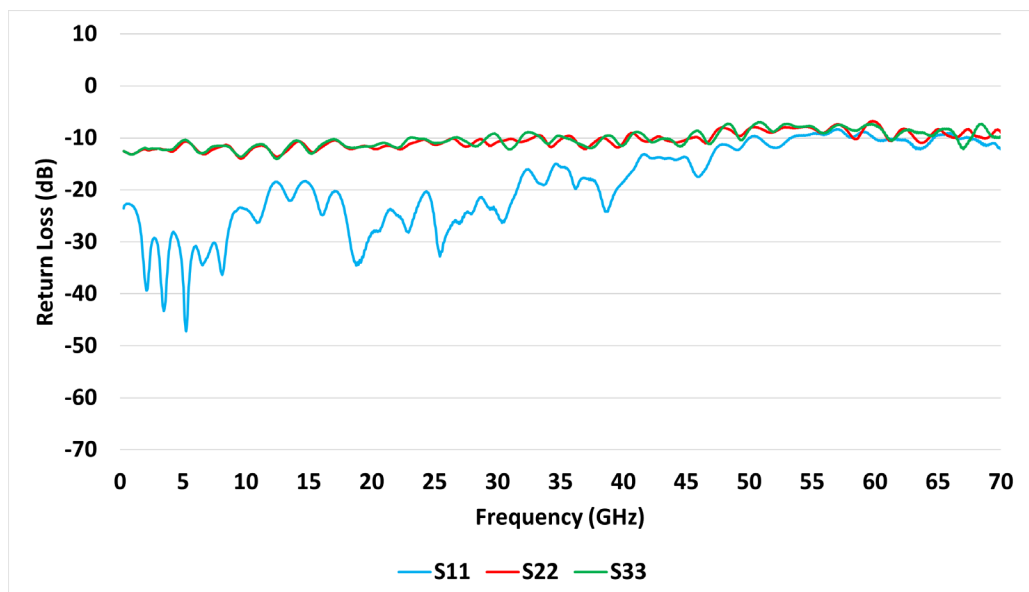

Figure 2: HL9407 Single-ended Return Loss

HL940x Mixed-mode Insertion Loss

Mixed-mode S-parameters are useful for characterizing the performance of differential circuits such as broadband baluns.

Figures 3-4 show the insertion loss of an HL9407 balun in mixed mode to 70 GHz. Other models show similar performance within their respective specified bandwidths.

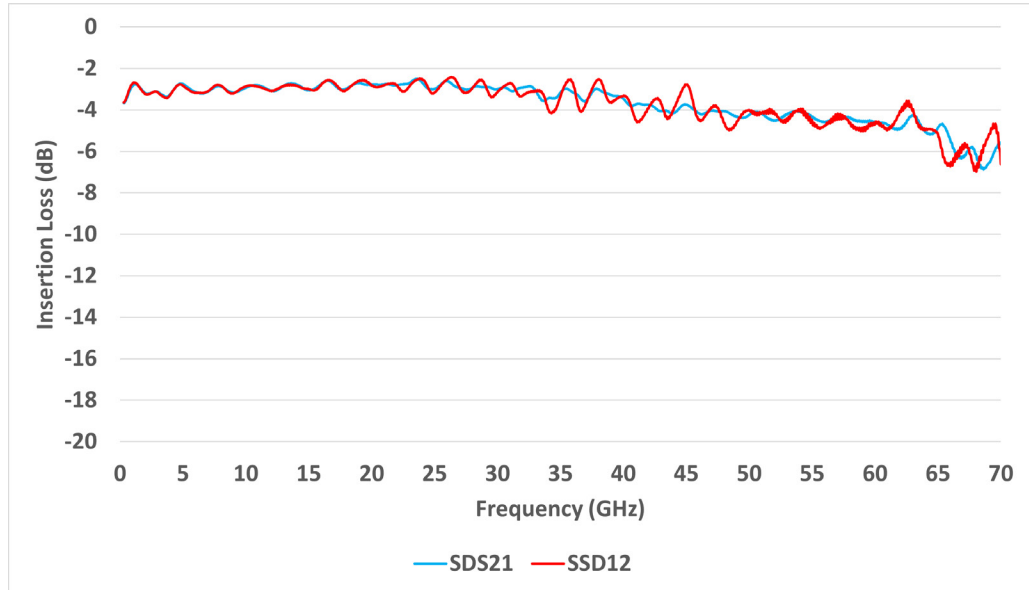

Figure 3: HL9407 Differential Mode Insertion Loss

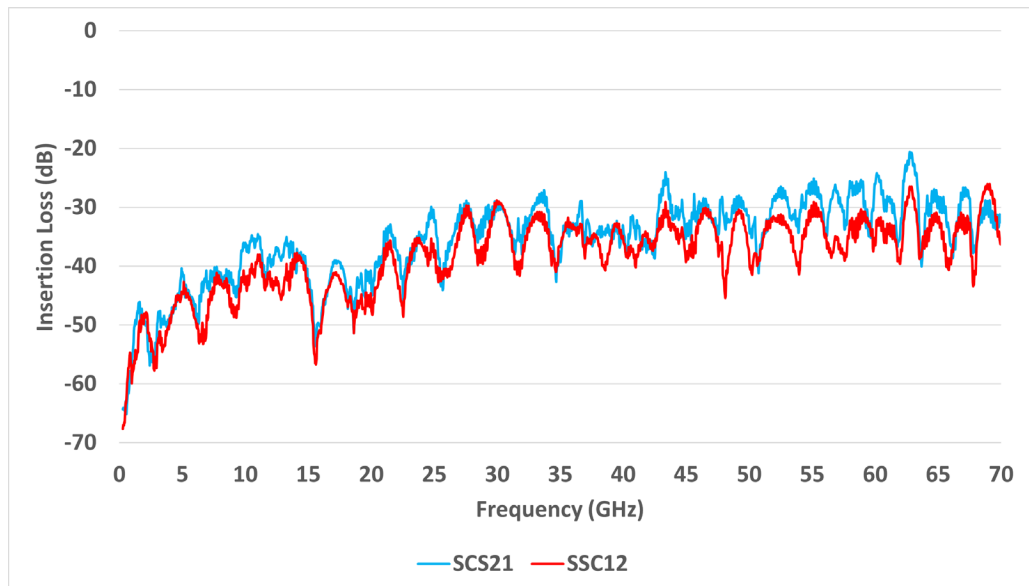

Figure 4: HL9407 Common Mode Insertion Loss

HL940x Mixed-mode Return Loss

Figure 5 shows the typical mixed-mode return loss of the unbalanced and balanced ports of an HL9407 to 70 GHz. Other models show similar performance within their respective specified bandwidths.

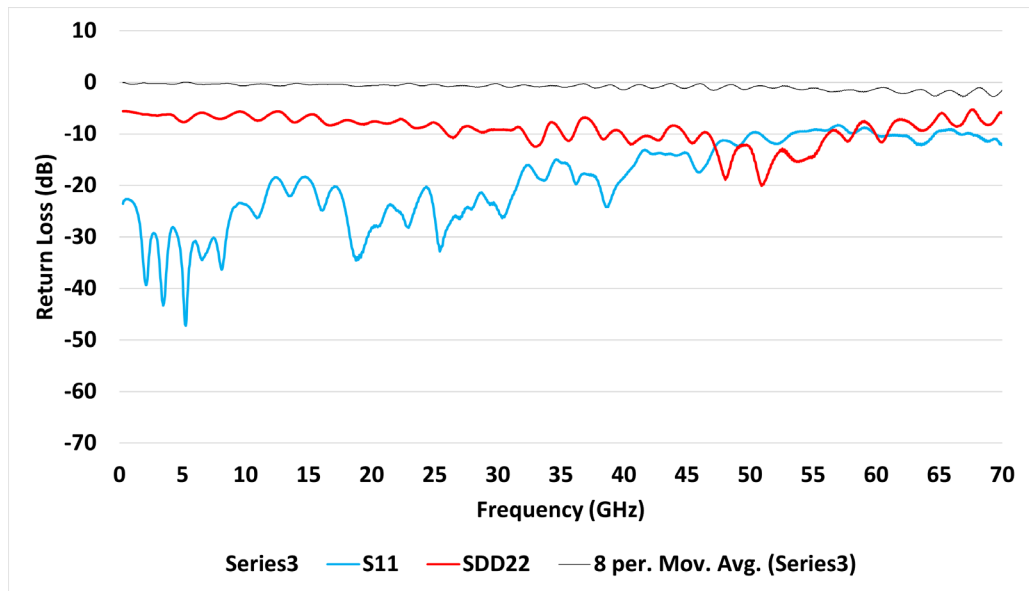

Figure 5: HL9407 Mixed-mode Return Loss

HL940x Common-mode Rejection Ratio

Figure 6 shows the typical common-mode rejection ratio (CMRR) of an HL9407.

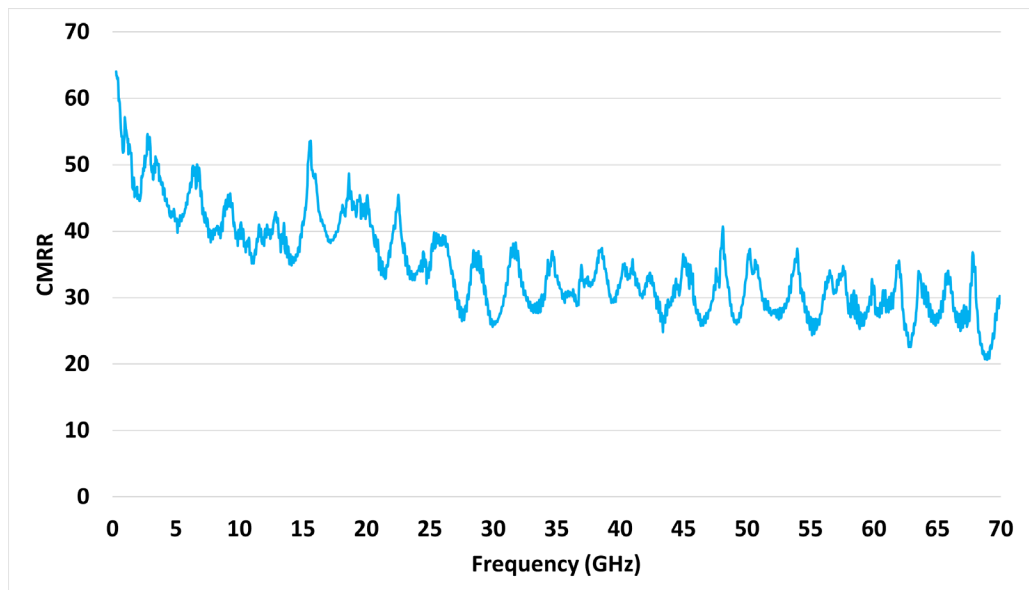

Figure 6: HL9407 Common Mode Rejection Ratio (CMRR)

HL940x Group Delay and Phase Match

Figure 7 shows the typical group delay of an HL9407 used as a signal splitter. The average slope of the phase mismatch, shown in Figure 8, is equal to the group delay mismatch. Other models show similar performance within their respective specified bandwidths.

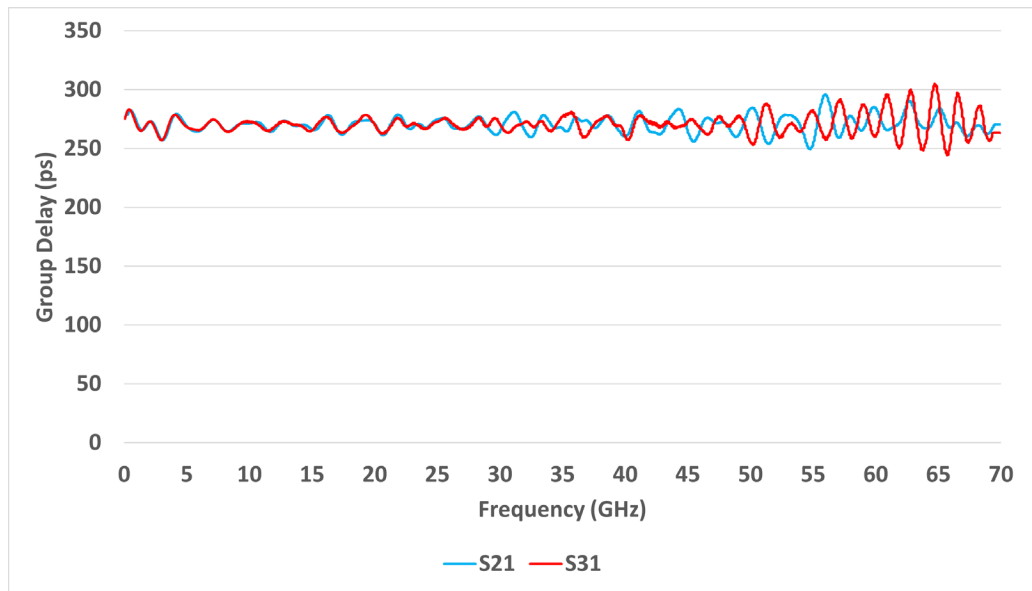

Figure 7: HL9407 Single-ended Group Delay

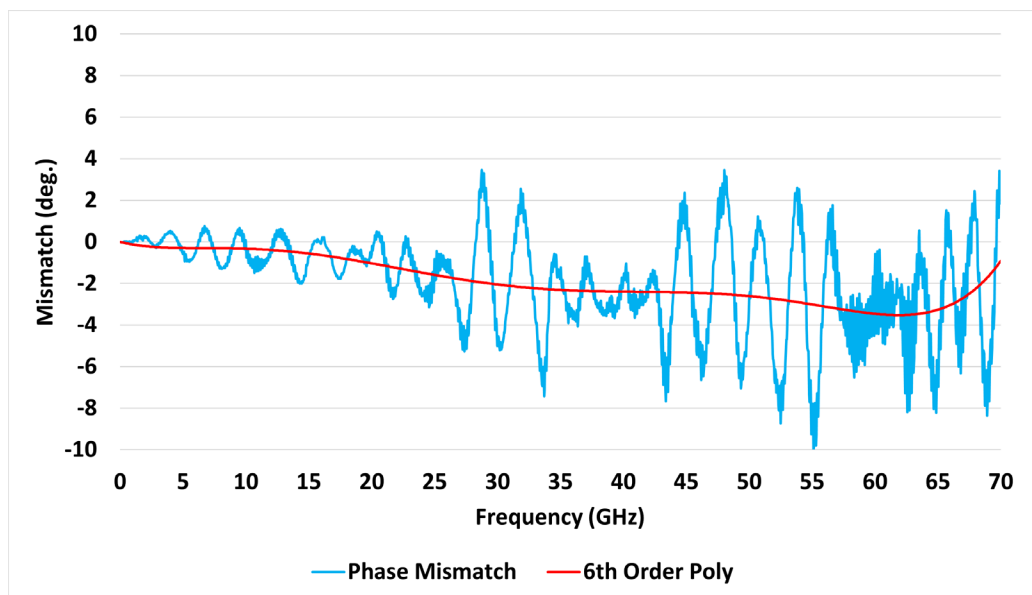

Figure 8: HL9407 Phase Mismatch



HL940x Eye Diagrams

The eye diagrams in *Figures 9-10* show a 56 Gbps PRBS11 pattern passed through an HL9407.

Figures 11-12 show a 112 Gbps PAM4 signal passed through the HL9407.

All plots have an input signal amplitude of 395 mV and are shown at 89 mV/div.

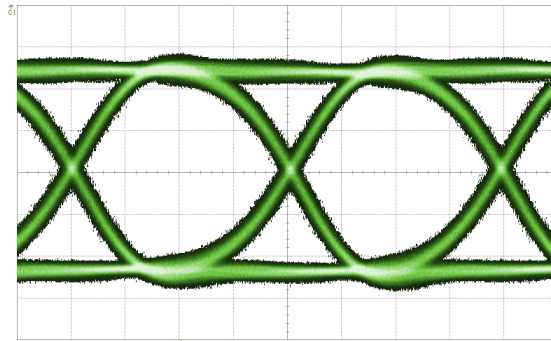

Figure 9: HL9407 56 Gbps PRBS 11, RF Input

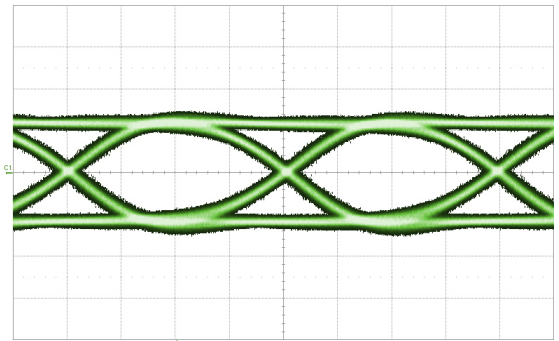

Figure 10: HL9407 56 Gbps PRBS 11, RF Output

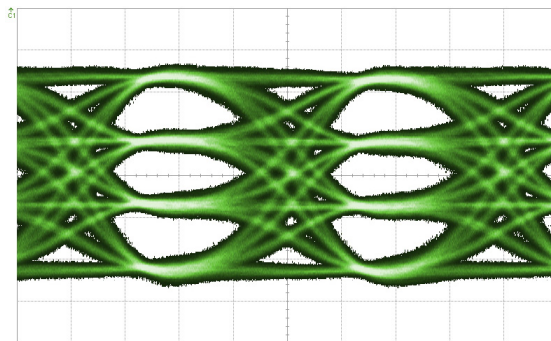

Figure 11: HL9407 112 Gbps PAM4, RF Input

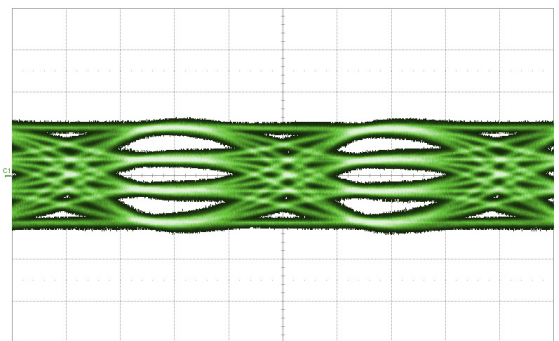

Figure 12: HL9407 112 Gbps PAM4, RF Output

HL940x Dimensional Drawing

Figure 13 shows a mechanical drawing of an HL9407. Unless otherwise noted, all units are in inches. Other models vary in width based on connectors. See page 2 for full dimensions.

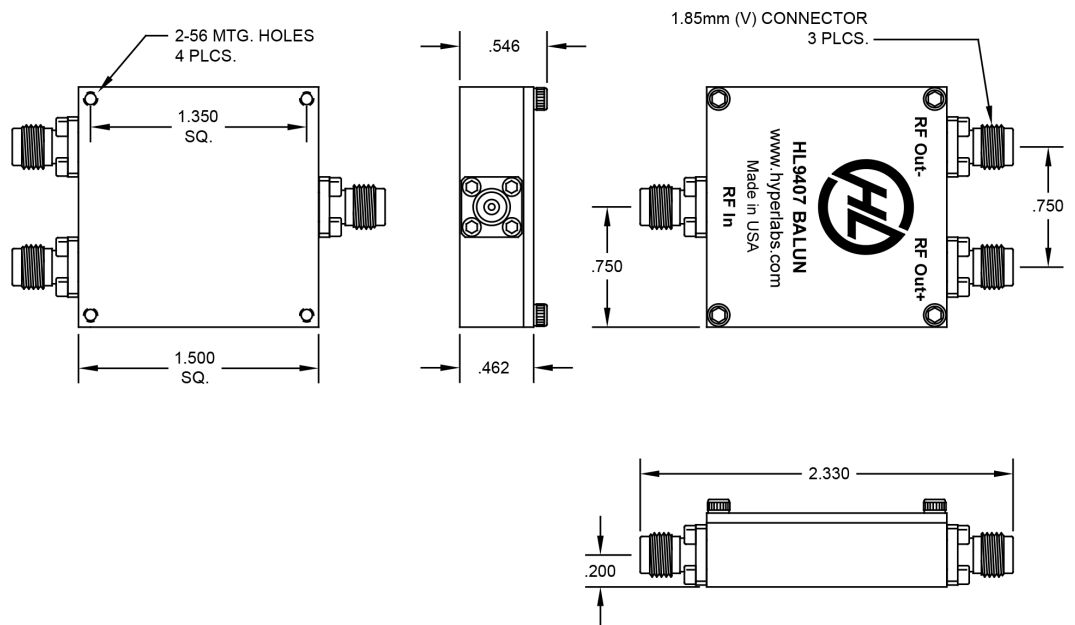

Fig. 13: HL9407 Mechanical Drawing