

HL9448/9 Series Bias Tees (160 kHz to 110 GHz, 175 mA)

Features and Technical Specifications¹ (HL9449 shown)

PRODUCT SUMMARY

The HL9448 and HL9449 are ultra-broadband bias tees with a typical insertion loss of 2.5 dB throughout the specified bandwidth range.

The HL9448/9 blocks any existing DC signal and allows for the insertion of a DC bias current into a circuit with minimal perturbation of the impedance of a 50 ohm transmission line.

These devices can be used for biasing amplifiers, lasers, optical modulators, and other devices.

Applications include 112 Gbps PAM4 communications systems, optical communication systems, high-speed data systems, level shifting, cascading, and interfacing between devices with incompatible DC operating points.

MODELS & OPTIONS

The following models are available:

- HL9448**, 95 GHz
- HL9449**, 110 GHz

The following options are available:

- M**, matched pair
- U**, unmatched part(s)

- 11**, 11 V breakdown
- 30**, 30 V breakdown

- JJ**, jack AC, AC+DC
- JP**, jack AC, plug AC+DC
- PJ**, plug AC, jack AC+DC
- PP**, plug AC, AC+DC

Bandwidth	160 kHz to > 110 GHz (opt. -11) 200 kHz to > 110 GHz (opt. -30)
Amplitude Match (opt. -M only)	± 0.1 dB, f ≤ 110 GHz, all options See Fig. 1
Phase Match (opt. -M only)	± 4°, f = 40 GHz
Insertion Loss	< 2.5 dB, 160 kHz to 110 GHz, (opt. -JJ) See Fig. 1
Return Loss	15 dB f ≤ 35 GHz, all options 10 dB f > 35 GHz, all options See Fig. 3
Breakdown Voltage	11 V, max (opt. -11) 30 V, max (opt. -30)
Maximum Current	175 mA
Rise Time (10-90%)	3.2 ps, all options
Impedance	50 Ω
Dimensions (W x D x H)	1.95" x 1.30" x 0.53" 49.53 x 33.02 x 13.46 mm
Weight	24 g (0.85 oz.)
Connectors (AC / AC+DC)	1.0 mm, jack/jack (opt. -JJ) 1.0 mm, jack/plug (opt. -JP) 1.0 mm, plug/jack (opt. -PJ) 1.0 mm, plug/plug (opt. -PP)
Temperature Limits	-40° to +70° C, operating
RoHS Compliant	Yes, assembled with lead-free solder
REACH Compliant	Yes
Warranty	1 year, see website
NOTE 1 - Unless otherwise noted, the specifications in this table are typical for Model Number HL9449. See page 2 for full specifications.	

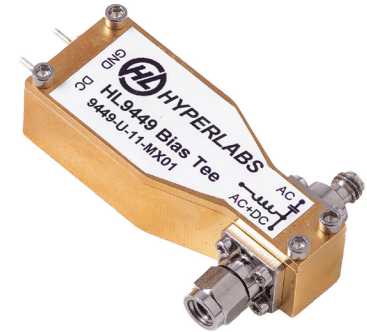

HL9449, Option -U-JP shown

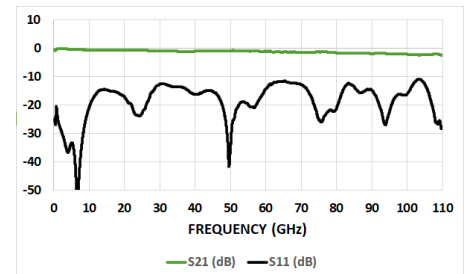

Typical HL9449 Insertion and Return Loss

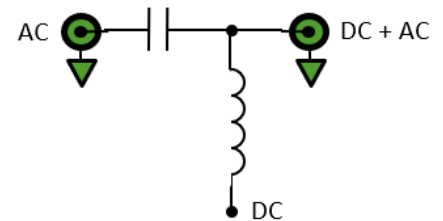

HL9449 Schematic and Port Assignments

HL9448 and HL9449 Full Specifications

Parameter	HL9448	HL9449	Comments
Upper Frequency Limit	> 95 GHz	> 110 GHz	3 dB roll-off point, relative to nominal insertion loss
Lower Frequency Limit See Fig. 2	160 kHz (opt. -11) 200 kHz (opt. -30)		3 dB roll-off point
Maximum Current	175 mA		
Breakdown Voltage	11 V, max (opt. -11) 30 V, max (opt. -30)		
Amplitude Match See Fig. 5	± 0.1 dB, f ≤ 110 GHz, all options		Typical, opt. -M
Phase Match	± 4°, f = 40 GHz (opt. -M)		Typical, opt. -M
Insertion Loss See Fig. 1	2.5 dB 160 kHz ≤ f ≤ 95 GHz	2.5 dB 160 kHz ≤ f ≤ 110 GHz	Typical
Return Loss See Fig. 3	15 dB, f ≤ 35 GHz 10 dB, f > 35 GHz		Typical, within specified operating frequency
Rise Time	3.7 ps	3.2 ps	Typical
Group Delay See Fig. 4	103 ps	105 ps	All options
Impedance	50 Ω		Input and Output
DC Resistance	2 Ω		DC to AC+DC
Connectors	1.0 mm, jack-jack 1.0 mm, jack-plug 1.0 mm, plug-jack 1.0 mm, plug-plug		According to specified option -JJ, -JP, -PJ, or -PP
Dimensions (W x D x H)	1.95" x 1.30" x 0.53" 49.53 x 33.02 x 13.46 mm		Package including connectors
Weight	24 g (0.85 oz.)		
Operating Temperature	-40° to +70° C		Case temperature
RoHS Compliant	Yes, assembled with lead-free solder		
REACH Compliant	Yes		
Warranty	1 year, repair or replacement; see website for details		

HL9449 Bandwidth and Insertion Loss

Figure 1 shows the insertion loss and bandwidth of the HL9449 opt. -11 from 10 MHz to 110 GHz.

Figure 2 shows the low-frequency response of this same configuration to 100 Hz.

Other models show similar performance within their respective specified bandwidths.

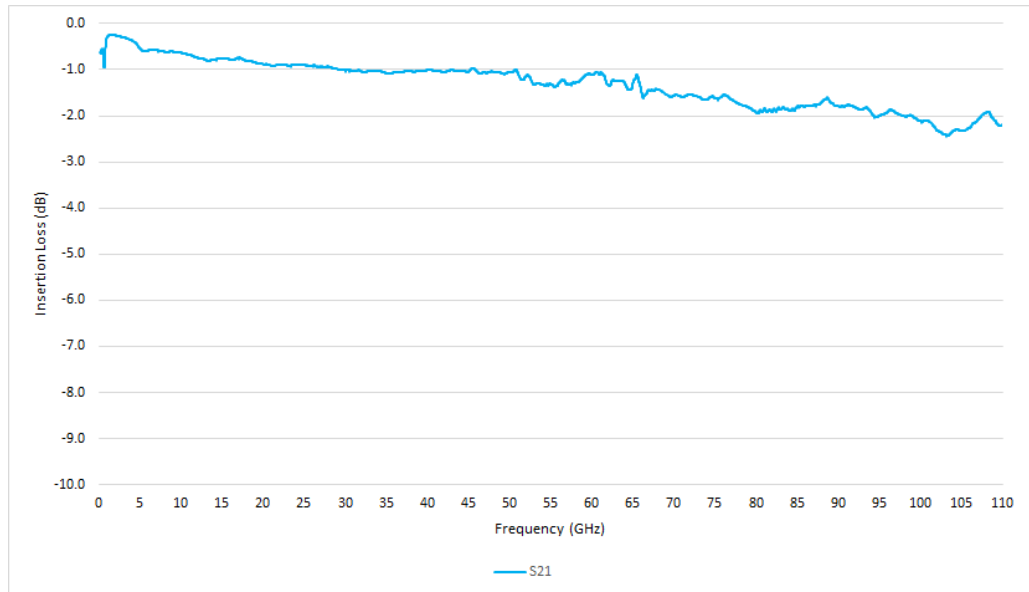

Figure 1: Typical HL9449 Bandwidth and Insertion Loss

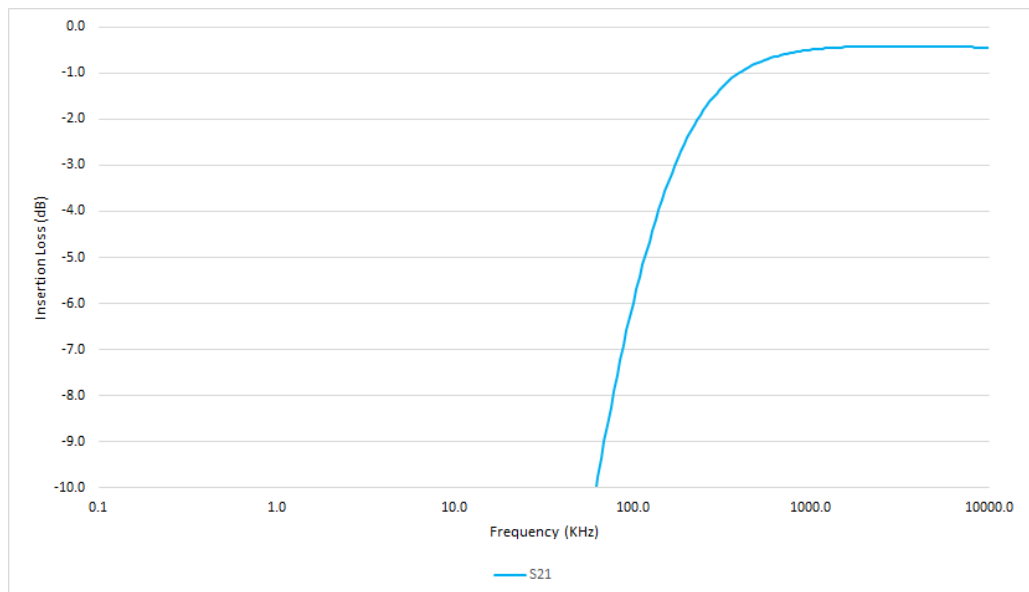

Figure 2: Typical HL9449 Low-frequency Performance (opt. -30)

HL9449 Return Loss and Group Delay

Figure 3 shows Return Loss and Figure 4 shows the Group Delay on a typical HL9449 opt. -11 from 10 MHz to 110 GHz.

Other models show similar performance within their respective specified bandwidths.

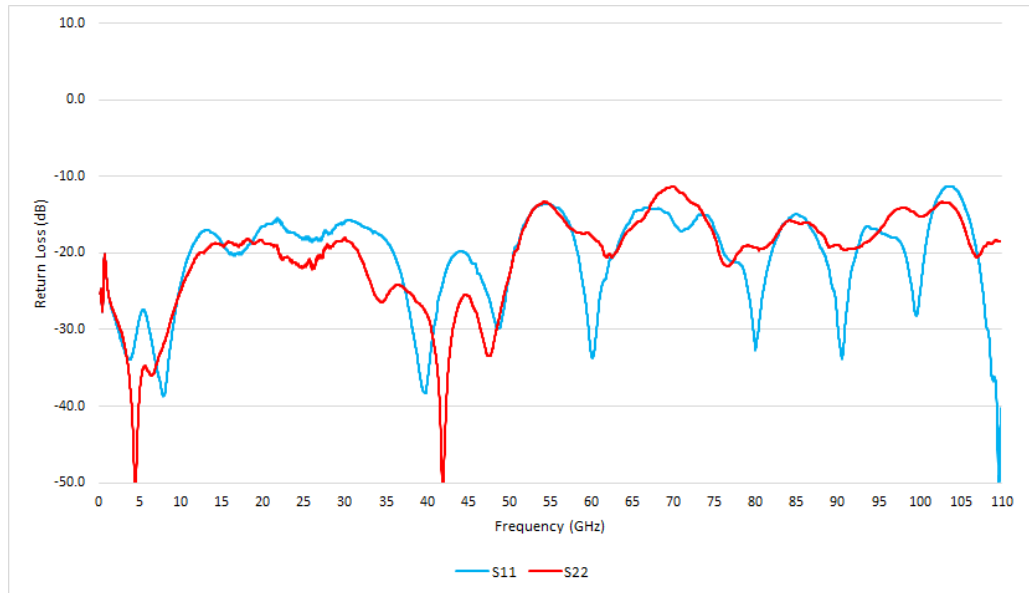

Figure 3: Typical HL9449 Return Loss

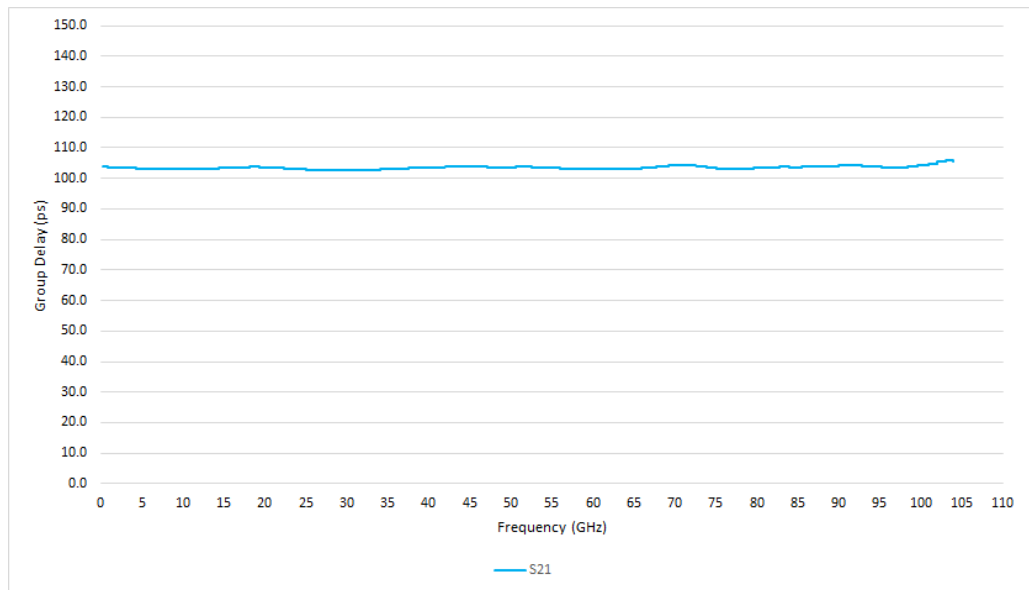

Figure 4: Typical HL9449 Group Delay

HL9449 Matching

Figure 5 shows the typical amplitude match between a matched pair of HL9449 opt. -M-11 devices from 10 MHz to 110 GHz.

Other models show similar performance within their respective specified bandwidths.

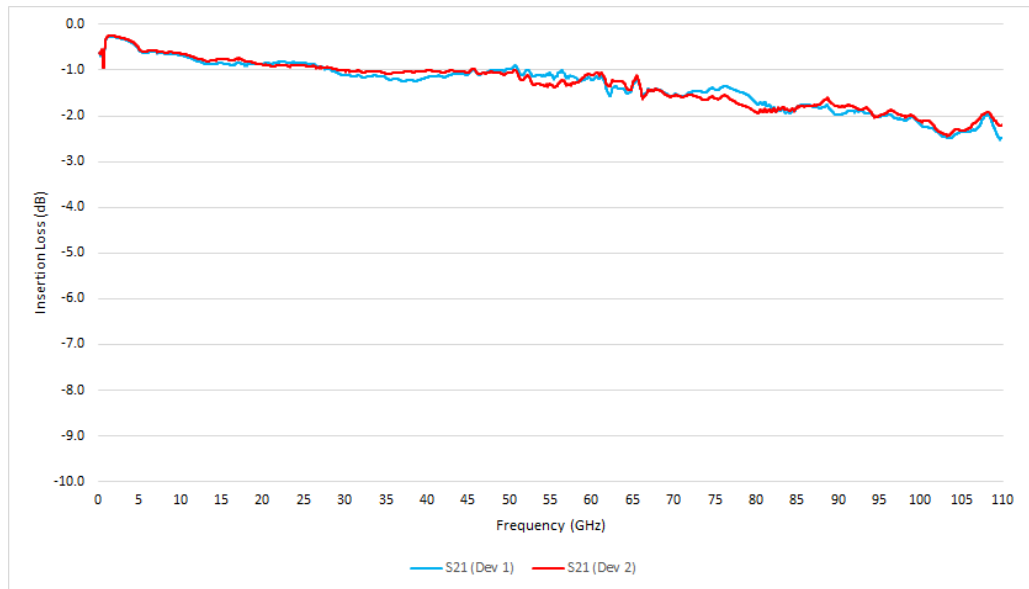

Figure 5: Typical HL9449 Amplitude Matching (opt. -M)

HL9449 Dimensional Drawing

Figure 6 shows a mechanical drawing of an HL9449 (opt. -JJ). Unless otherwise noted, all units are in inches. See page 2 for full dimensions.

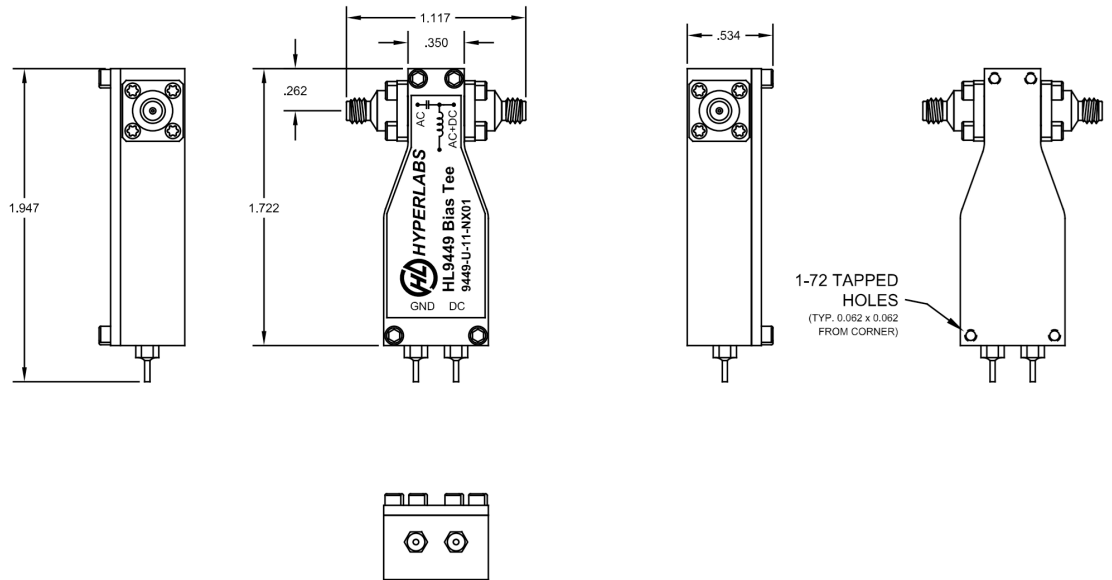

Fig 6: HL9449 Mechanical Drawing