

HL950x Series Integrated Baluns (500 kHz to 50 GHz)

Features and Technical Specifications¹ (HL9505-DDD shown)

PRODUCT SUMMARY

The HL950x series are ultra-broadband 180° signal splitters and combiners with integrated components such as DC blocks and bias tees.

These devices offer the same industry-best amplitude and phase match of other HYPERLABS baluns. Integrating commonly-used components reduces overall system size as well as cost.

They are suitable for use in 112 Gbps PAM4 communications systems, high-speed analog-to-digital conversion, frequency-response testing for differential devices, and many other applications.

DEPLOYMENT NOTES

When the device is used as a signal combiner using differential signals with unmatched source impedance, attenuators (3-6 dB) may be required to improve isolation.

MODELS & OPTIONS

The following models and options are available:

HL9502, 26.5 GHz

HL9504, 40 GHz

HL9505, 50 GHz

-DDD, DC Block, all ports

Bandwidth	500 kHz to 50 GHz
Amplitude Match	± 0.1 dB, $f \leq 40$ GHz ± 0.25 dB, $f > 40$ GHz See Fig. 1
Phase Match	$\pm 4^\circ$, $f = 20$ GHz $\pm 8^\circ$, $f = 40$ GHz See Fig. 8
Insertion Loss	6 dB, single-ended reference See Figs. 1, 3-4
Return Loss	> 15 dB, unbalanced port, $f \leq 30$ GHz > 10 dB, unbalanced port, $f > 30$ GHz > 10 dB, balanced ports, $f \leq 30$ GHz > 7.5 dB, balanced ports, $f > 30$ GHz See Figs. 2, 5
Capacitance	47 nF, all ports (opt. -DDD)
Group Delay	≈ 320 ps See Fig. 7
Breakdown Voltage	30 V
Max Input Power	1 W (+30 dBm)
Connectors	Available with SMA, 2.92 mm, or 2.4 mm connectors depending on model and bandwidth
Temperature Limits	-40° to $+100^\circ$ C, operating
RoHS Compliant	Yes, assembled with lead-free solder
REACH Compliant	Yes
Warranty	1 year, see website
NOTE 1 - Unless otherwise noted, the specifications in this table are typical for Model Number HL9505-DDD. Full specifications for this and related models are available on Page 2 of this datasheet.	



HL9505-DDD, standard configuration shown

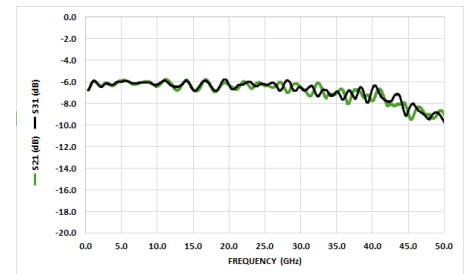

Typical HL9505-DDD Single-ended Insertion Loss

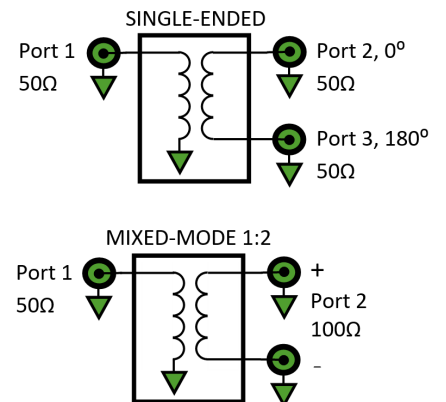

HL950x Schematic and Port Assignments

HL950x Full Specifications

Parameter	HL9502	HL9504	HL9505	Comments
Upper Frequency Limit	26.5 GHz	40 GHz	50 GHz	3 dB roll-off point, relative to nominal insertion loss
Lower Frequency Limit	500 kHz	500 kHz	500 kHz	3 dB roll-off point; based on balun performance
Amplitude Match <i>See Fig. 1</i>	± 0.1 dB	± 0.1 dB	± 0.1 dB, f ≤ 40 GHz ± 0.25 dB, f > 40 GHz	
Phase Match <i>See Fig. 8</i>	± 4°, f = 20 GHz	± 4°, f = 20 GHz	± 4°, f = 20 GHz ± 8°, f = 40 GHz	
Insertion Loss <i>See Figs. 1, 3-4</i>	6 dB			Single-ended reference
Return Loss <i>See Figs. 2, 5</i>	> 15 dB, unbal. port > 10 dB, bal. ports	> 15 dB, f ≤ 30 GHz, unbal. port > 12.5 dB, f > 30 GHz, unbal. port > 10 dB, f ≤ 30 GHz, bal. ports > 7.5 dB, f > 30 GHz, bal. ports	> 15 dB, f ≤ 30 GHz, unbal. port > 12.5 dB, f > 30 GHz, unbal. port > 10 dB, f ≤ 30 GHz, bal. ports > 7.5 dB, f > 30 GHz, bal. ports	unbal. = unbalanced bal. = balanced
Rise Time	13 ps	9 ps	7 ps	
CMRR <i>See Fig. 6</i>	> 30 dB, f ≤ 20 GHz	> 30 dB, f ≤ 20 GHz > 20 dB, f > 20 GHz	> 30 dB, f ≤ 25 GHz > 20 dB, f > 25 GHz	Typical
Group Delay <i>See Fig. 7</i>	≈ 320 ps	≈ 320 ps	≈ 320 ps	
Max Input Power	1 W (+30 dBm)			
Impedance	50 Ω			Input and Outputs
Connectors	SMA, 3x jack/female SMA plug connectors upon request	2.92 mm, 3x jack/female 2.92 mm plug connectors upon request	2.4 mm, 3x jack/female 2.4 mm plug connectors upon request	
Dimensions (W x D x H)	2.57" x 1.64" x 0.55" 65.3 x 41.7 x 14 mm	2.57" x 1.64" x 0.55" 65.3 x 41.7 x 14 mm	2.73" x 1.64" x 0.55" 69.3 x 41.7 x 14 mm	Package including connectors
Weight	61 g (2.15 oz.)			
Operating Temp.	-40° to +100° C			Case temperature
RoHS Compliant	Yes, assembled with lead-free solder			
REACH Compliant	Yes			
Warranty	1 year, repair or replacement; see website for details			

HL950x Single-ended Insertion Loss and Return Loss

Bandwidth for all HYPERLABS baluns is defined as the range of frequencies where insertion loss is within 3 dB of the nominal level (6 dB) in single-ended mode.

Figure 1 shows the insertion loss and amplitude match of an HL9505-DDD in single-ended mode.

Figure 2 shows the return loss of all ports in single-ended mode.

Other models show similar performance within their respective specified bandwidths.

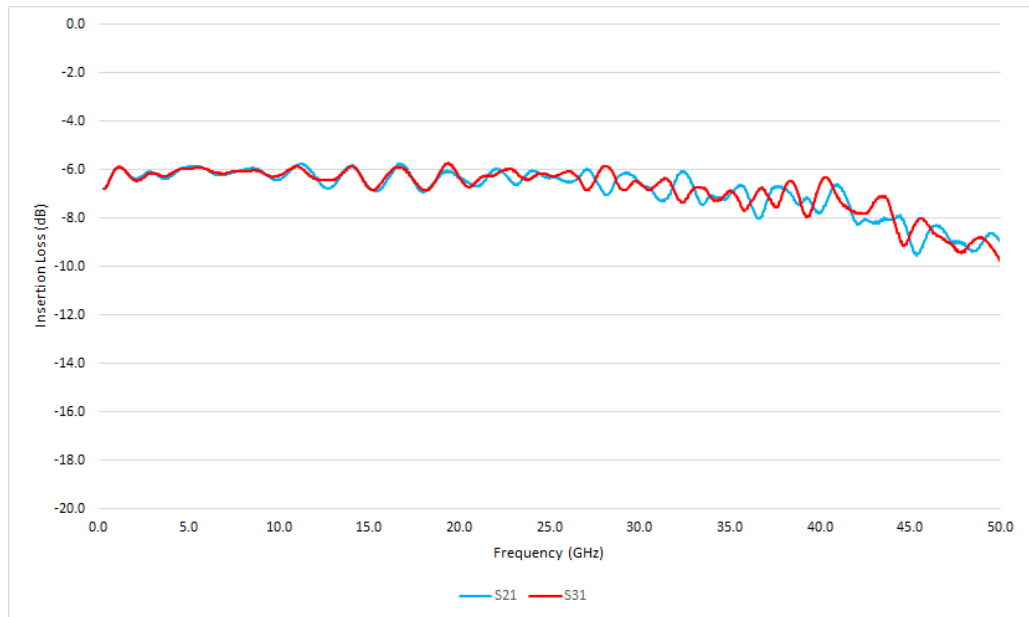

Figure 1: HL9505-DDD Single-ended Insertion Loss

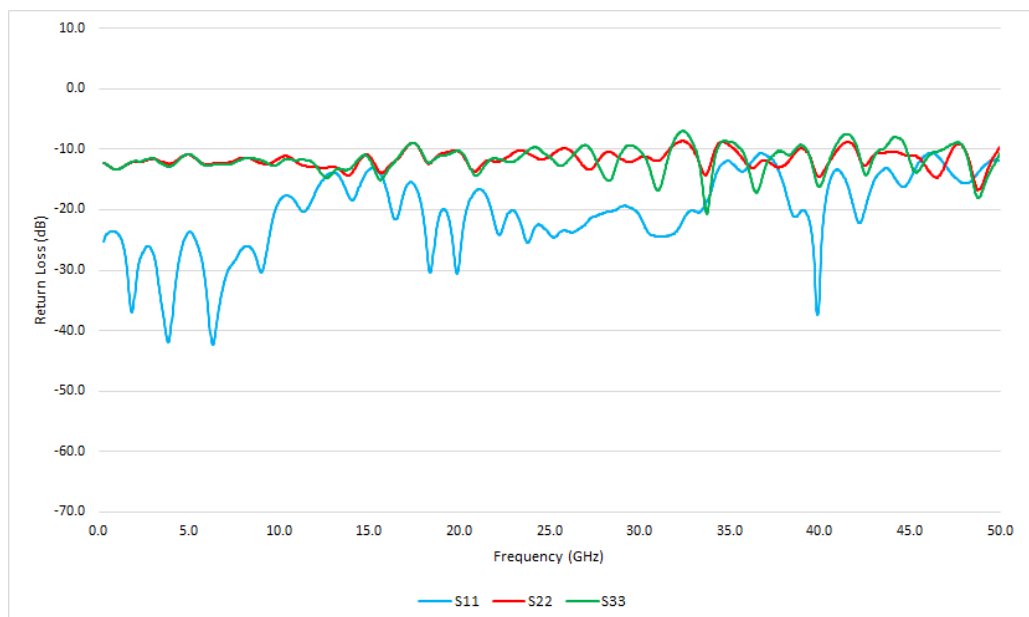

Figure 2: HL9505-DDD Single-ended Return Loss

HL950x Mixed-mode Insertion Loss

Mixed-mode S-parameters are useful for characterizing the performance of differential circuits such as broadband baluns.

Figures 3-4 show the insertion loss of an HL9505-DDD balun in mixed mode to 70 GHz. Other models show similar performance within their respective specified bandwidths.

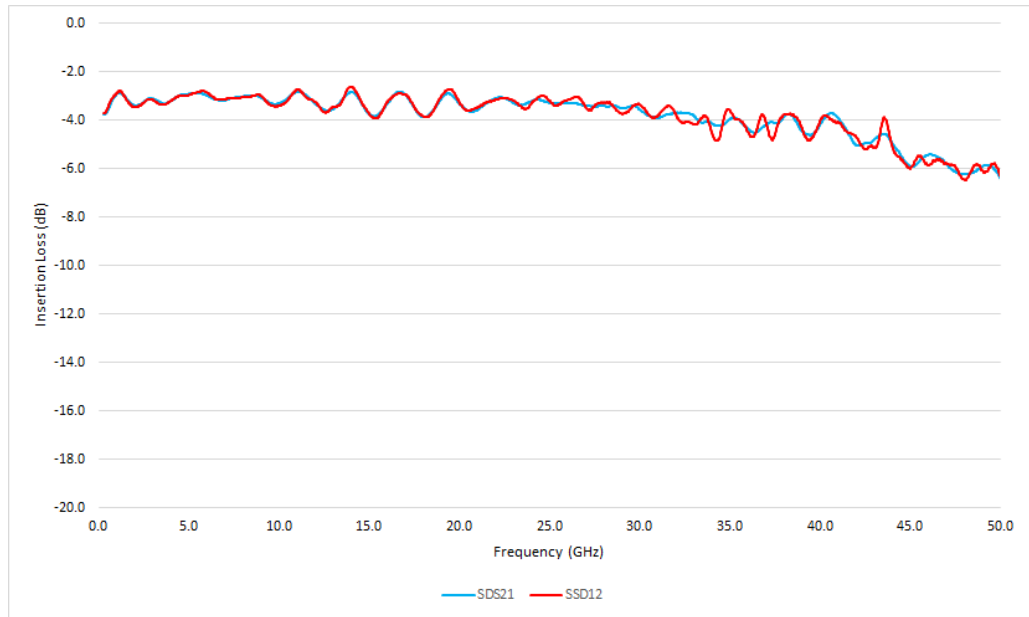

Figure 3: HL9505-DDD Differential Mode Insertion Loss

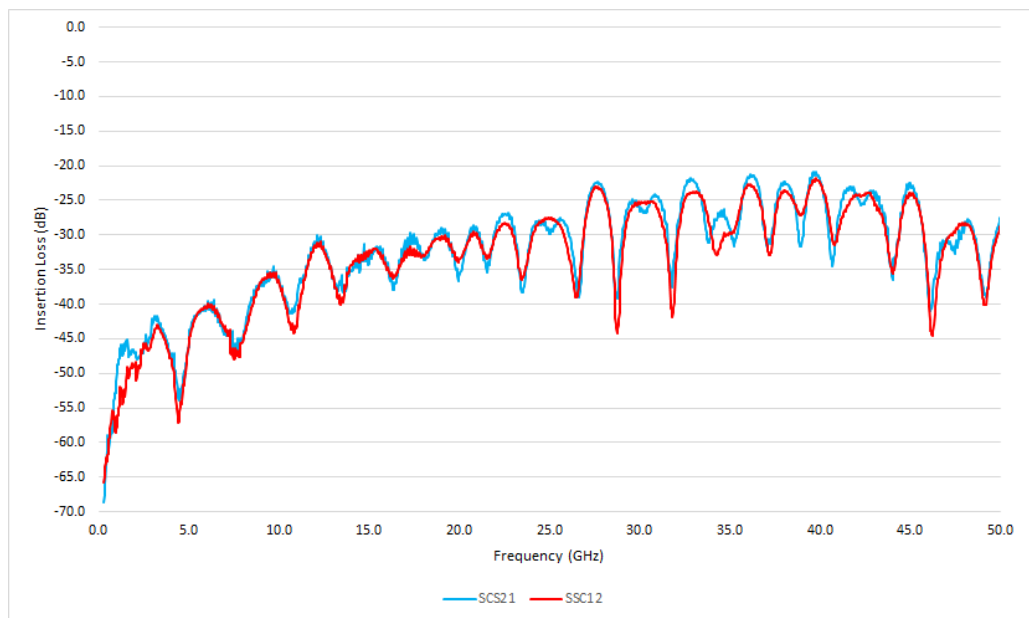

Figure 4: HL9505-DDD Common Mode Insertion Loss

HL950x Mixed-mode Return Loss

Figure 5 shows the typical mixed-mode return loss of the unbalanced and balanced ports of an HL9505-DDD to 70 GHz. Other models show similar performance within their respective specified bandwidths.

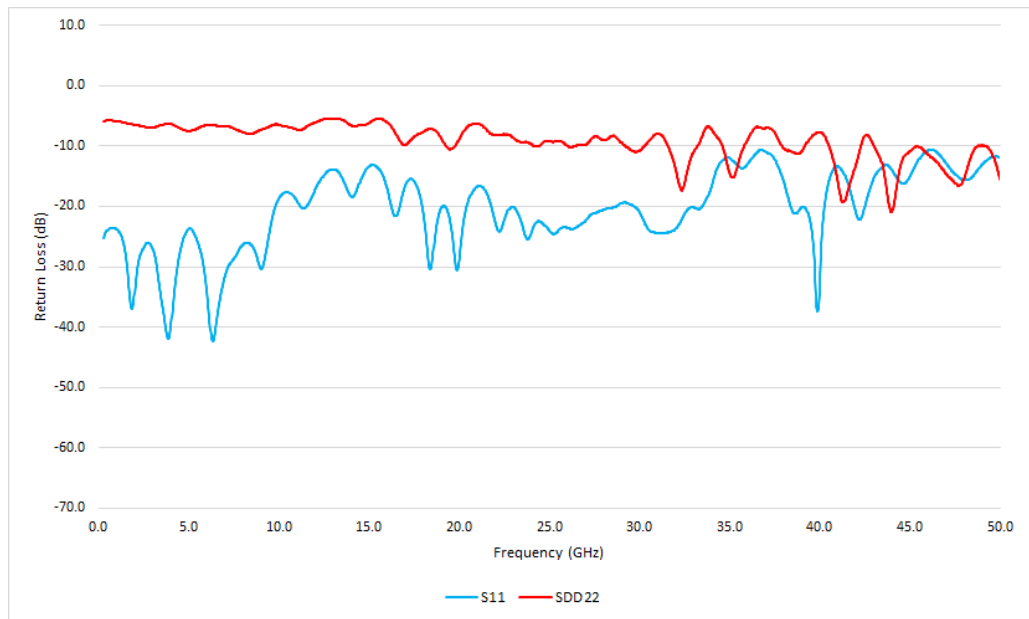

Figure 5: HL9505-DDD Mixed-mode Return Loss

HL950x Common-mode Rejection Ratio

Figure 8 shows the typical common-mode rejection ratio (CMRR) of an HL9505-DDD.

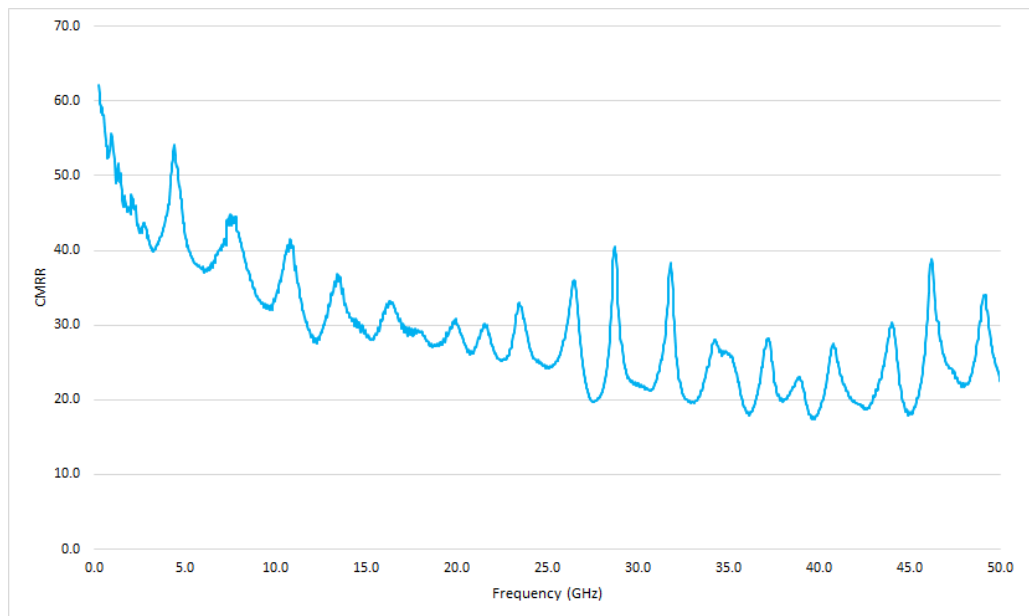

Figure 6: HL9505-DDD Common Mode Rejection Ratio (CMRR)

HL950x Group Delay and Phase Match

Figure 6 shows the typical group delay of an HL9505-DDD used as a signal splitter. The average slope of the phase mismatch, shown in Figure 7, is equal to the group delay mismatch. Other models show similar performance within their respective specified bandwidths.

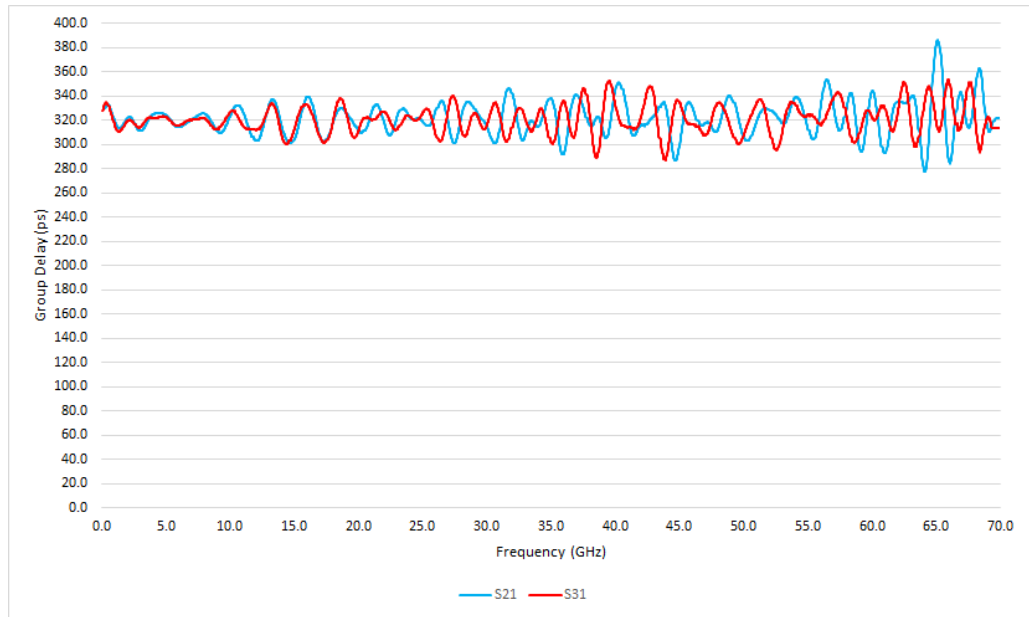

Figure 7: HL9505-DDD Single-ended Group Delay

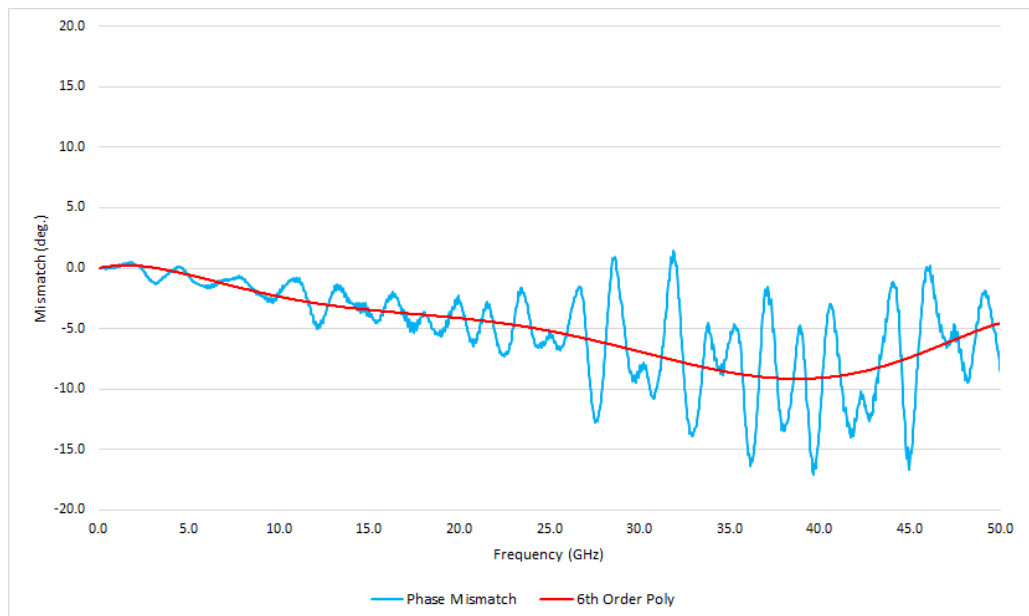

Figure 8: HL9505-DDD Phase Mismatch



HL950x Eye Diagrams

The eye diagrams in *Figures 9-10* show a 56 Gbps PRBS11 pattern passed through an HL9505-DDD.

Figures 11-12 show a 112 Gbps PAM4 signal passed through the HL9505-DDD.

All plots have an input signal amplitude of 395 mV and are shown at 89 mV/div.

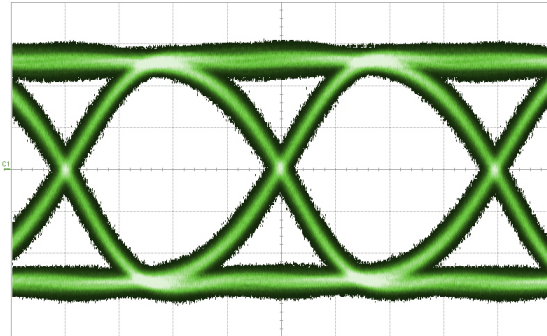

Figure 9: HL9505-DDD 56 Gbps PRBS 11, RF Input

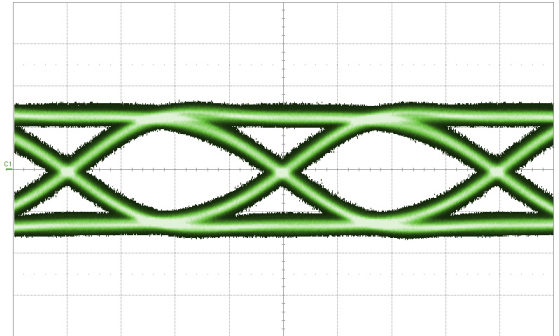

Figure 10: HL9505-DDD 56 Gbps PRBS 11, RF Output

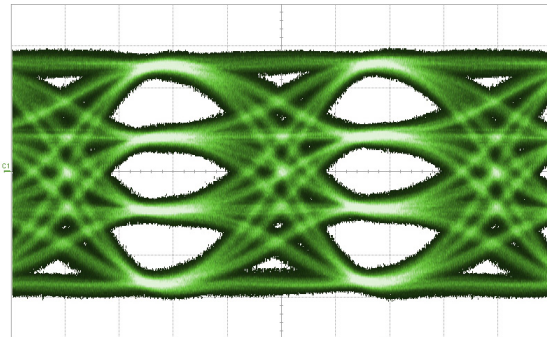

Figure 11: HL9505-DDD 112 Gbps PAM4, RF Input

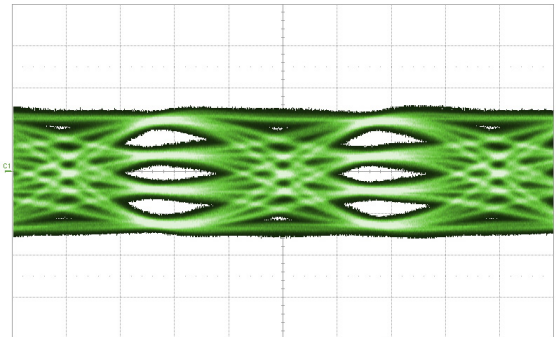

Figure 12: HL9505-DDD 112 Gbps PAM4, RF Output

HL950x Dimensional Drawing

Figure 13 shows a mechanical drawing of an HL9505-DDD. Unless otherwise noted, all units are in inches. Other models vary in width based on connectors. See page 2 for full dimensions.

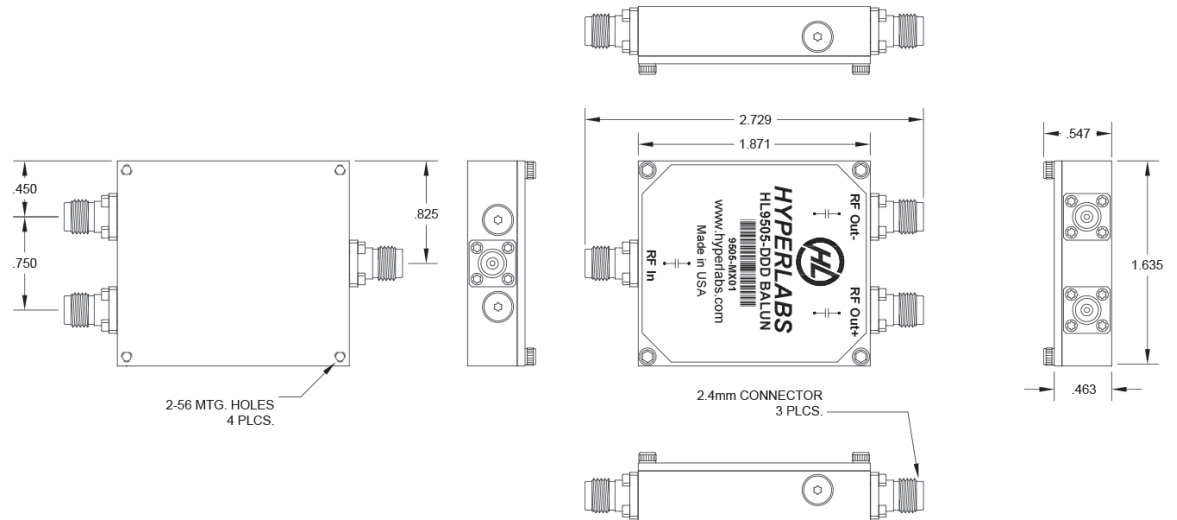

Fig. 13: HL9505-DDD Mechanical Drawing