

FEATURES

LO/RF Frequency:	14.0 – 18.0 GHz
Image Rejection:	32 dB
LO-RF Isolation:	50 dB
Input IP3:	+23 dBm
Input P1dB:	+14 dBm
Size:	1.35" X 2.0" [3.4 cm X 5.1 cm]

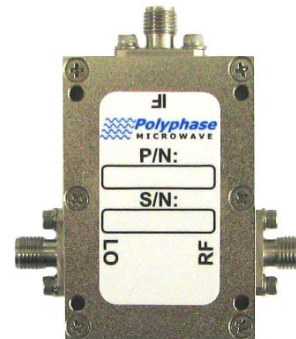

DESCRIPTION

The IRM140180B image-reject mixer is ideal for high performance microwave downconverters and receivers. The desired RF sideband is downconverted to the IF while the unwanted RF image is internally rejected.

The IRM140180B exhibits excellent image rejection over multi-octave IF frequency bandwidths. In-stock IF bands include:

- 10 MHz to 50 MHz
- 30 MHz to 90 MHz

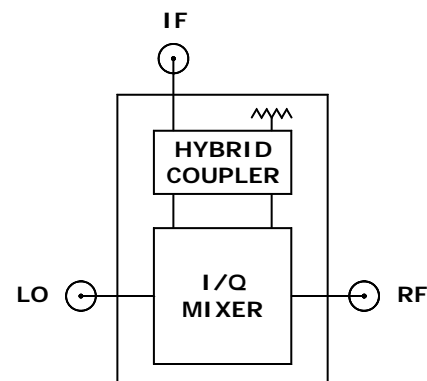
Other common IF bands are available. Please specify IF=RF-LO or IF=LO-RF and IF band when ordering.



ELECTRICAL SPECIFICATIONS

Test Conditions: +25°C, LO Input = +15 dBm, RF input = 0 dBm @ LO+30 MHz unless otherwise noted.

PARAMETER	TEST CONDITIONS	MIN	TYP	MAX	UNITS
LO Frequency Range		14.0		18.0	GHz
LO Power		+14	+15	+17	dBm
LO VSWR			2.0:1		Ratio
RF VSWR			2.0:1		Ratio
IF Output Impedance			50		Ω
Conversion Loss			8.5	10.5	dB
Noise Figure			9	11	dB
Input IP3	2-Tone, $\Delta f = 1$ MHz		+23		dBm
Input P1dB			+14		dBm
LO-RF Isolation	No RF input	35	50		dB
LO-IF Isolation	No RF input		55		dB
Image Rejection	Over IF Frequency Band	24	32		dB
Operating Temperature Range		-40		+85	°C
LO/RF Input Power w/o Damage				+23	dBm

TYPICAL PERFORMANCE CHARACTERISTICS

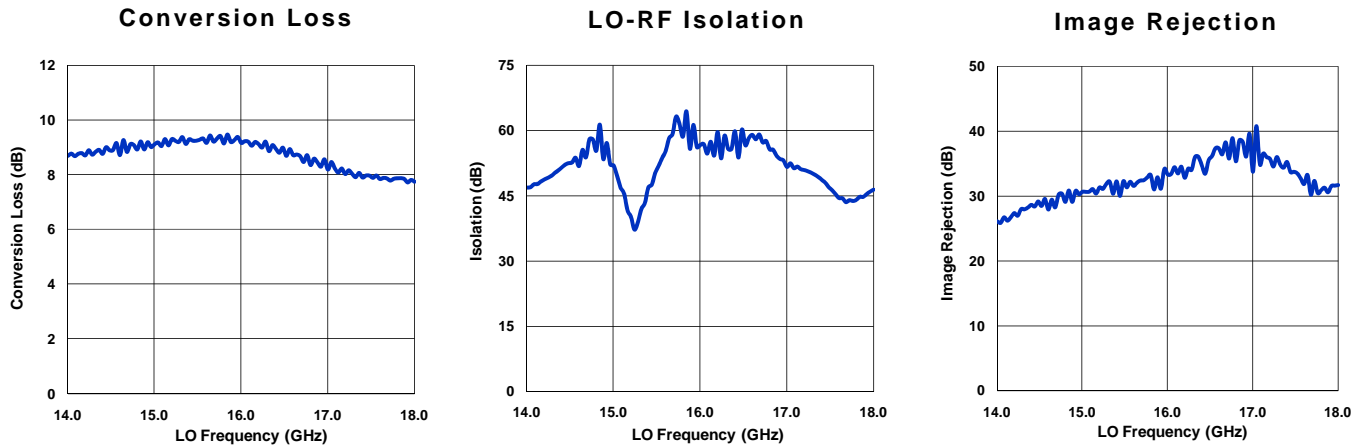
Standard Test Conditions: +25°C, LO Input = +15 dBm, RF Input = 0 dBm @ LO+30 MHz.



DIMENSION DRAWING

