

**FEATURES**

LO/RF Frequency:	2300 – 2600 MHz
Input IP2:	+65 dBm
Input IP3:	+15 dBm
Input P1dB:	+6 dBm
Amplitude imbalance:	0.05 dB rms
Quadrature phase error:	0.5° rms
LO Power:	+14 dBm

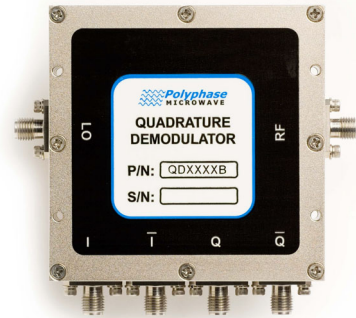

**DESCRIPTION**

The QD2326B is a quadrature (I/Q) demodulator optimized for direct conversion receivers. When the passive demodulator is supplied with a LO drive signal, the RF input is directly converted to differential I and Q baseband outputs.

Internally matched lowpass filters provide anti-alias functionality for interfacing to high-speed A/D converters.

For more information on interfacing the QD2326B to differential A/D converters and single-ended loads, please see Application Note 102A, "Interface Circuits for the QD Series Quadrature Demodulators."

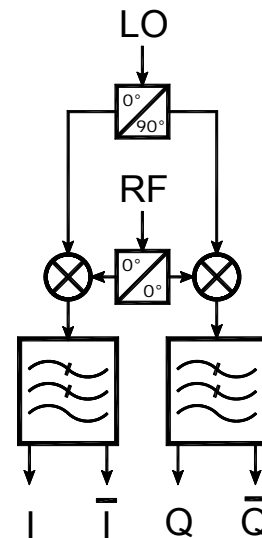

**TYPICAL APPLICATION: DIRECT CONVERSION RECEIVER**

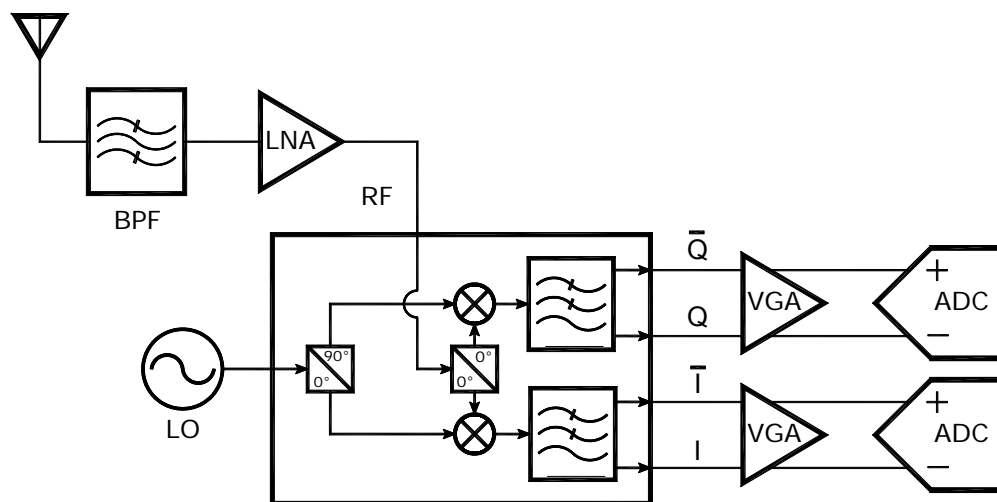

**ELECTRICAL SPECIFICATIONS**

Test Conditions: +25°C, LO = +14 dBm, RF = 0 dBm @ LO+100 kHz unless otherwise noted.

PARAMETER	TEST CONDITIONS	MIN	TYP	MAX	UNITS
Frequency Range <sup>1</sup>		2300		2600	MHz
LO Power		+13	+14	+16	dBm
LO VSWR			1.5:1		Ratio
RF VSWR			2.0:1		Ratio
I/Q Baseband Filter Bandwidth <sup>2</sup>	<1 dB Flatness	DC		275	MHz
I/Q Baseband Filter Stop Band <sup>2</sup>	>25 dB Rejection	450		5000	MHz
I/Q Differential Output Impedance			100		Ω
I/Q Baseband DC Offset	Into 100 Ω load	-5		+5	mV
Conversion Loss			8.5	10	dB
Noise Figure	No RF input drive		9		dB
Input IP2			+65		dBm
Input IP3	2-Tone, Δf = 1 MHz		+15		dBm
Input P1dB			+6		dBm
LO-RF Isolation	No RF input drive		65		dB
LO-IF Isolation	No RF input drive		70		dB
Amplitude Imbalance		-0.2	±0.05	+0.2	dB
Quadrature Phase Error		-2	±0.5	+2	Degree
Operating Temperature Range		-40		+85	°C
LO/RF Input Power w/o Damage				+25	dBm

Notes:

1. When RF > LO frequency:  $I = \cos(t)$ ,  $\bar{I} = -\cos(t)$ ,  $Q = \sin(t)$ ,  $\bar{Q} = -\sin(t)$
2. Standard lowpass filters. Contact factory for other options.

**CASE DRAWING**

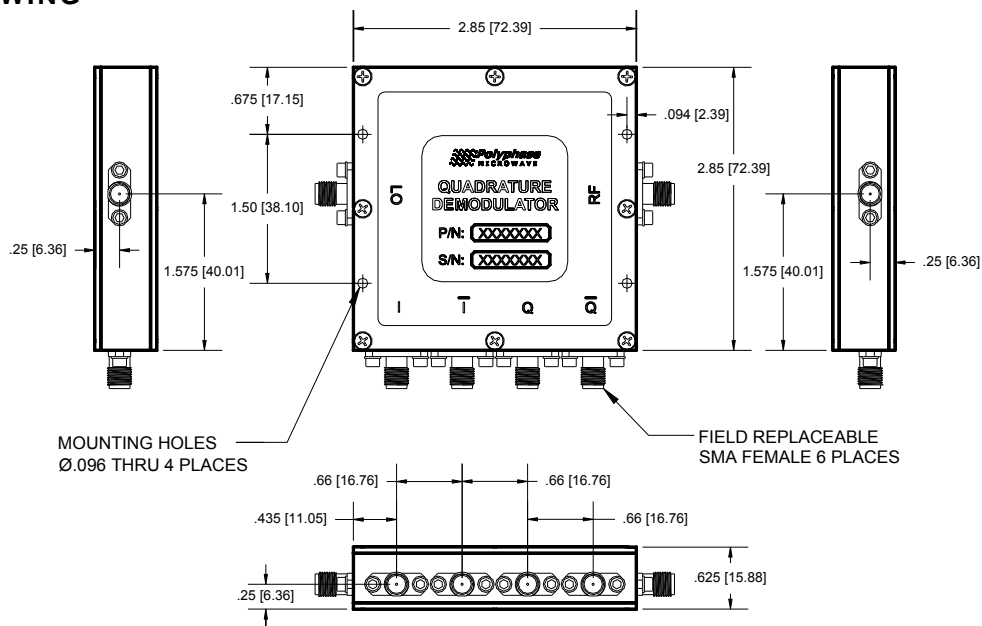

**TYPICAL PERFORMANCE CHARACTERISTICS**

Standard Test Conditions: +25°C, LO = +14 dBm, RF input = 0 dBm @ LO+100 kHz.

**Conversion Loss**

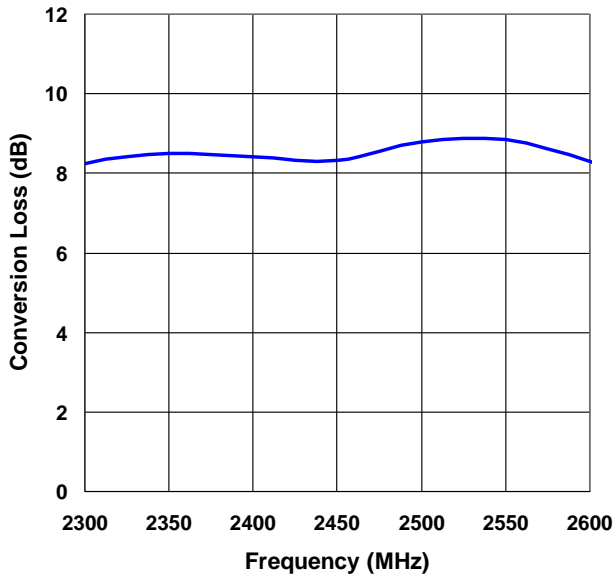

**LO-RF Isolation**

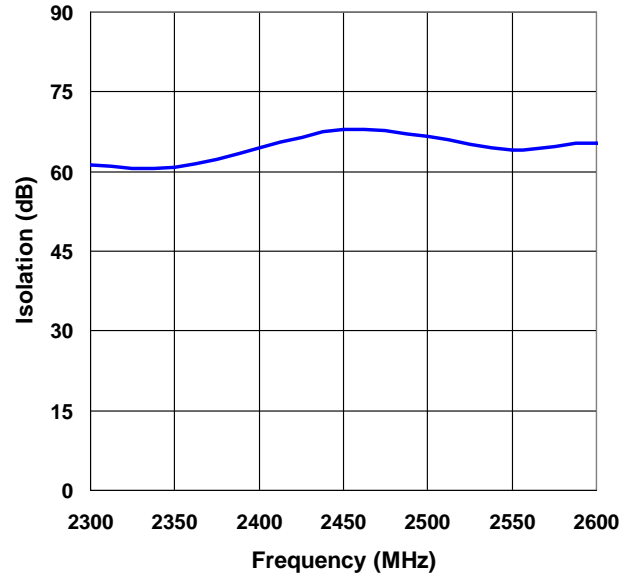

**Amplitude Imbalance**

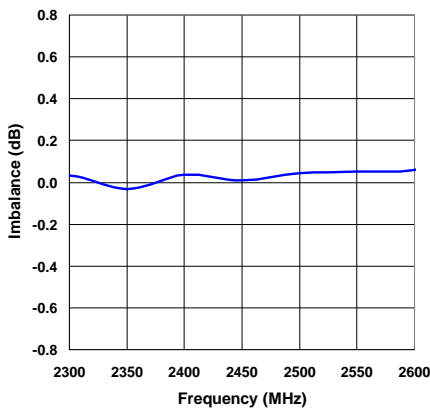

**Quadrature Phase Error**

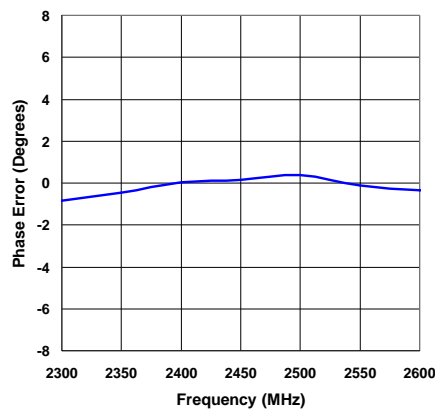

**DC Offsets**

