

Fiber Coupled Acousto-Optic Modulator/Shifter Low Loss



(1.4dB, 400 to 2300nm, 80 MHz, all fiber types) (patent pending)

DATASHEET

BUY NOW



Features

- Low optical Loss
- High Power
- Low Cost
- Stable
- All Fiber Compatible

Applications

- Fiber Lasers
- Pulse Picker
- Sensor

This AOMF series of fiberoptic acoustic modulators is optimized for low optical loss <1dB with 80MHz resonance frequency, providing a solution for fast amplitude modulation of laser light transmitting through a fiber with a convenient 0-5V control signal. We offer unique features of low insertion loss <1.4 dB, fast rise/fall~10ns, high optical power handling up to 50W, high on/off ratio >60dB, high polarization extinction >30dB, wide wavelength selection from 350 to 2400nm, and compatibility with all fiber types, as well as competitive cost. The device is normally opaque and becomes transparent when the acoustic bragg diffraction condition is met. It intrinsically produces a positive wavelength frequency shift, although a negative shift can be specially ordered. These modulators are often used in sensor, fiber laser systems, and as a pulsed picker for short pulse, high repetition rate fiber lasers.

The construction of AOM device consists of a pair of fiber optical collimators between an acousto-optic crystal having a piezo-actuator on the side. No epoxy is in the optical path.

Specifications

Parameter	Min	Typical	Max	Unit	
Center Wavelength	450	1550	2300	nm	
Wavelength Bandwidth		± 30		nm	
Acoustic Frequency		80		MHz	
Modulation Bandwidth	DC		19	MHz	
Wavelength Shift		80		MHz	
Insertion Loss ^[1]	(1030nm~1550nm)	0.8	1.4	2.5	dB
	(450nm~980nm)	1.2	2	3	dB
Polarization Dependent Loss		0.2	0.5	dB	
Extinction Ratio (On/Off) ^[2]	50	55	65	dB	
Rise/Fall Time ^[3]	25		55	ns	
Return Loss ^[4]	45	50	55	dB	
Voltage Standing Wave Ratio		1.2:1			
Polarization Extinction (PM)	18	20	25	dB	
Average Optical Power		0.5	20	W	
Input Impedance		50		Ω	
RF Power ^[5]		2.5	3.5	W	
Electrical Interface		SMA			
Ultrasonic Velocity		4200		m/s	
Operating Temperature	-10		65	°C	
Storage Temperature	-45		85	°C	

Notes:

- [1]. Without connector. Each connector typically adds 0.2-0.3dB, RL increase by 5dB, and ER reduces by 2dB. **1dB is for 80MHz 80ns rise/fall with special order**
PM connector key is aligned to the slow axis as a default.
Insertion Loss refers to output - input at ON state
- [2]. For Single Mode only, multimode reduces depend on mode filled ratio.
ER refers to output power ratio between ON/OFF states.
- [3]. (10%-90%). The rise/fall and bandwidth are related to the beam size, small beam has higher insertion loss. In another word, fast response with larger bandwidth will add insertion loss.
- [4]. 50dB is standard for SM, 45dB for 50/125
- [5]. The device is designed to be operated at 2.5W and meet the spec, but can handle a maximum of 3.5W with sufficient cooling

Note: The specifications provided are for general applications with a cost-effective approach. If you need to narrow or expand the tolerance, coverage, limit, or qualifications, please [click this link](#):

Legal notices: All product information is believed to be accurate and is subject to change without notice. Information contained herein shall legally bind Agiltron only if it is specifically incorporated into the terms and conditions of a sales agreement. Some specific combinations of options may not be available. The user assumes all risks and liability whatsoever in connection with the use of a product or its application.

Rev 07/23/24

Fiber Coupled Acousto-Optic Modulator/Shifter Low Loss



(1.4dB, 400 to 2300nm, 80 MHz, all fiber types) (patent pending)

DATASHEET

Mechanical Dimensions (mm)

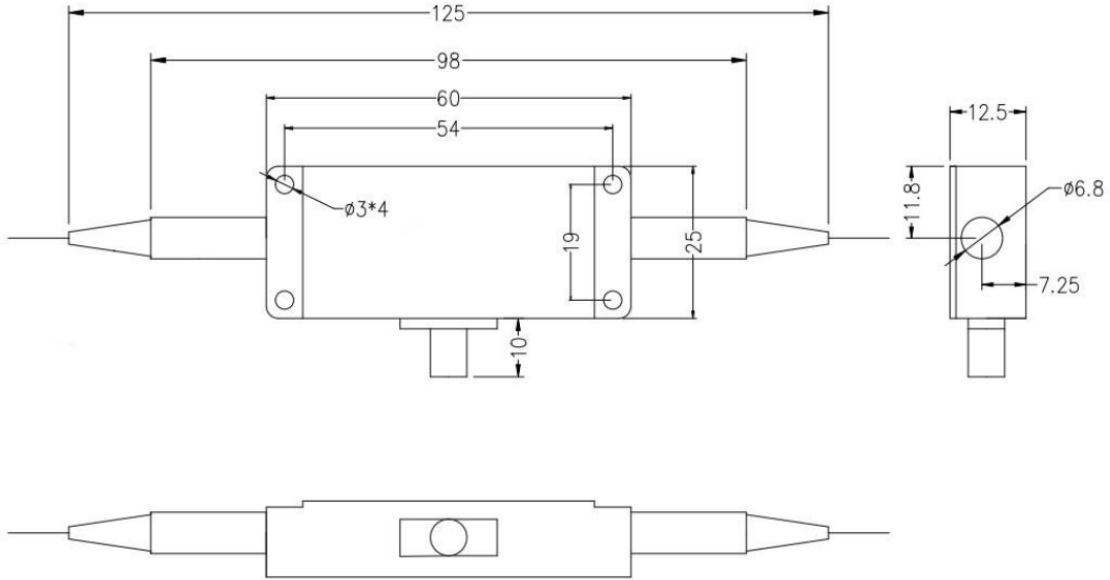

AOM

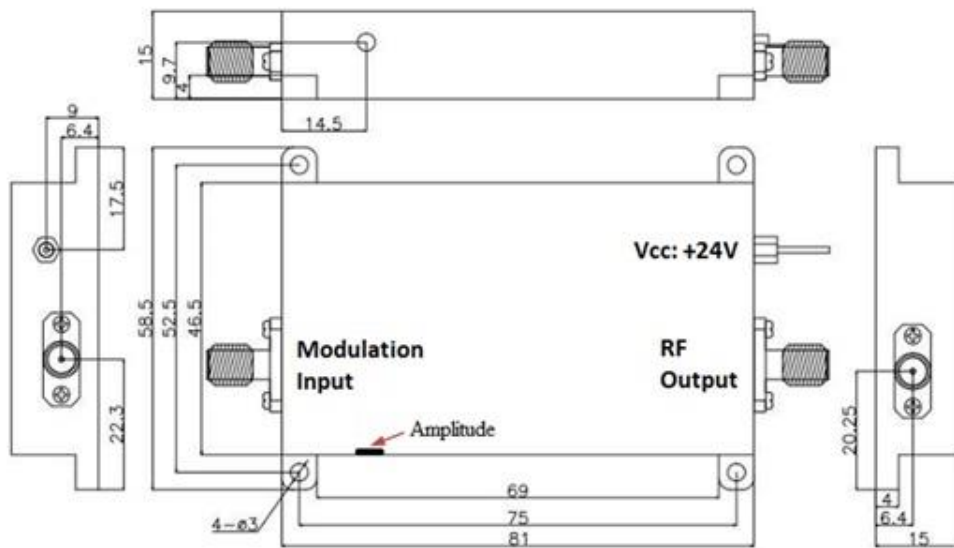

AOM Driver

*Product dimensions may change without notice. This is sometimes required for non-standard specifications.

Fiber Coupled Acousto-Optic Modulator/Shifter Low Loss



(1.4dB, 400 to 2300nm, 80 MHz, all fiber types) (patent pending)

DATASHEET

Electrical/Computer Connection

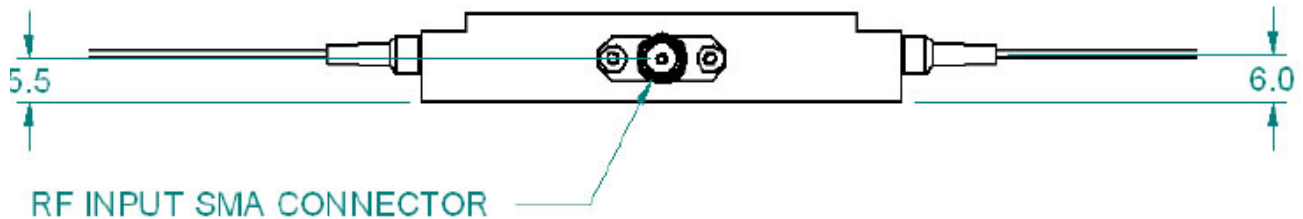

Ordering Information

Prefix	Type	Wavelength	Insertion ^[1]	Optical Power	Fiber Type	Fiber Cover	Fiber Length	Connector	ER ^[2]	Wavelength Shift
AOMF-	Special = 0	1060nm = 1 1550nm = 5 1310nm = 3 980 nm = 9 850 nm = 8 780 nm = 7 630 nm = 6 530 nm = A 450 nm = 4 2000nm = 2 Special = 0	2.5dB = 1 1.6dB = 2 1.5dB = 3	0.5W = 1 5W = 2 10W = 3 20W = 4 30W = 5	Select fiber below	0.9mm tube = 3 Special = 0	0.25m = 1 0.5m = 2 1.0 m = 3 Special = 0	None = 1 FC/PC = 2 FC/APC = 3 SC/PC = 4 SC/APC = 5 ST/PC = 6 LC/PC = 7 5WFC/PC = H 10WFC/PC = A	Non = 1 18dB = 2 20dB = 3 25dB = 4 29dB = 5	-80MHz = 1 +80MHz = 2

[1]. Without connector, each connector add 0.3dB. For 1310-1550nm. Short wavelength and >1900nm, the loss is higher

[2]. Polarization extinction ratio only for PM fiber

Marked in red on special order

Fiber Type Selection Table:

01	SMF-28	34	PM1550	71	MM 50/125µm
02		35	PM1950	72	MM 62.5µm
03		36	PM1310	73	
04	SM450	37	PM400	74	
05	SM1950	38	PM480	75	
06	SM600	39	PM630	76	
07	Hi780	40	PM850		
08	SM800	41	PM980		
09	SM980	42	PM780		
10	Hi1060	43			
11	SM400	44	PM405		
12		45	PM460		

Fiber Coupled Acousto-Optic Modulator/Shifter Low Loss



(1.4dB, 400 to 2300nm, 80 MHz, all fiber types) (patent pending)

DATASHEET

Acoustic Frequency

The operation of an acousto-optic modulator is based on the Bragg diffraction generated by an acoustic wave (traveling refractive grating) inside a crystal, as shown below. The **Acoustic Frequency** is fixed for each device. A RF voltage of the acoustic frequency is applied to the piezoelectric actuator attached to the crystal generating the acoustic wave. The higher the frequency, the higher the cost to make and higher the power consumption.

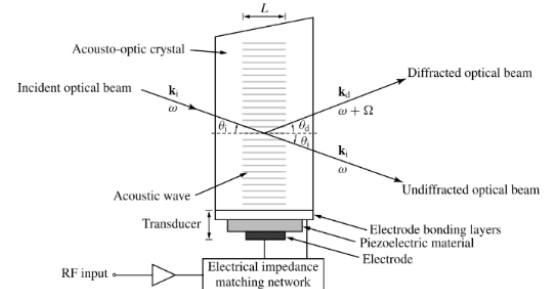

Modulation Bandwidth

An optical intensity modulator can be achieved by a driving circuitry in which the acoustic intensity inside the crystal varies with an input modulation signal. A typical acoustic driver output is shown below: a RF Input electrical signal modulates the intensity profile of the carrier oscillations (acoustic frequency), resulting in a modulated driving signal, which leads to an output optical intensity similar to the RF input. The acoustic frequency intrinsically determines the rise/fall of the optical modulation. The Modulation Bandwidth is proportional to the acoustic frequency. The optical response can be optimized to certain extend via the driving circuit such as digital or analog.

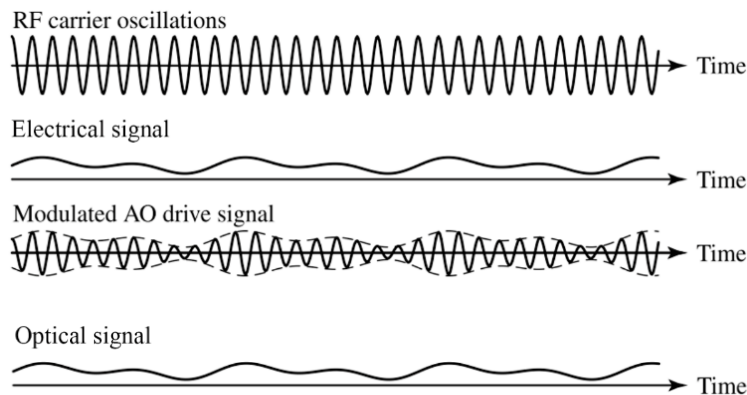

Optical Wavelength Shift

Due to an energy exchange, all acoustic optical devices apply a frequency shift to the diffracted output beams. These optical wavelength shifts are very small and proportional to the acoustic frequency. Depending on the selected Bragg angle, these devices will either up-shift or down-shift the laser light by the frequency of the applied RF signal.

Fiber Coupled Acousto-Optic Modulator/Shifter Low Loss



(1.4dB, 400 to 2300nm, 80 MHz, all fiber types) (patent pending)

DATASHEET

Deviation From Actuator Resonance

The piezoelectric actuator is operated at its mechanical resonance for high energy efficiency. When the driving frequency deviates from the actuator resonance, the diffraction efficacy reduces, leading to higher optical insertion loss.

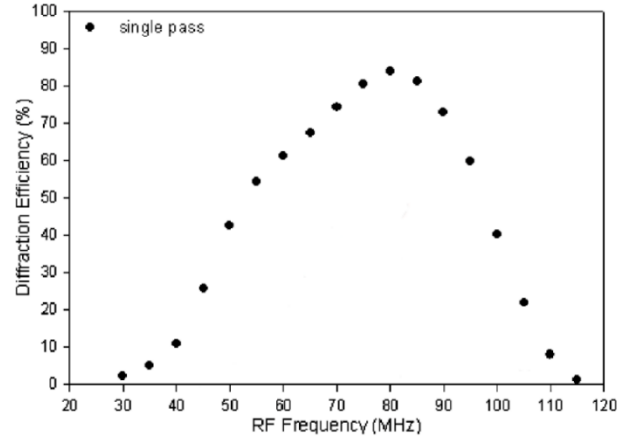

Typical Attenuation vs Control Signal for 200MHz AOM

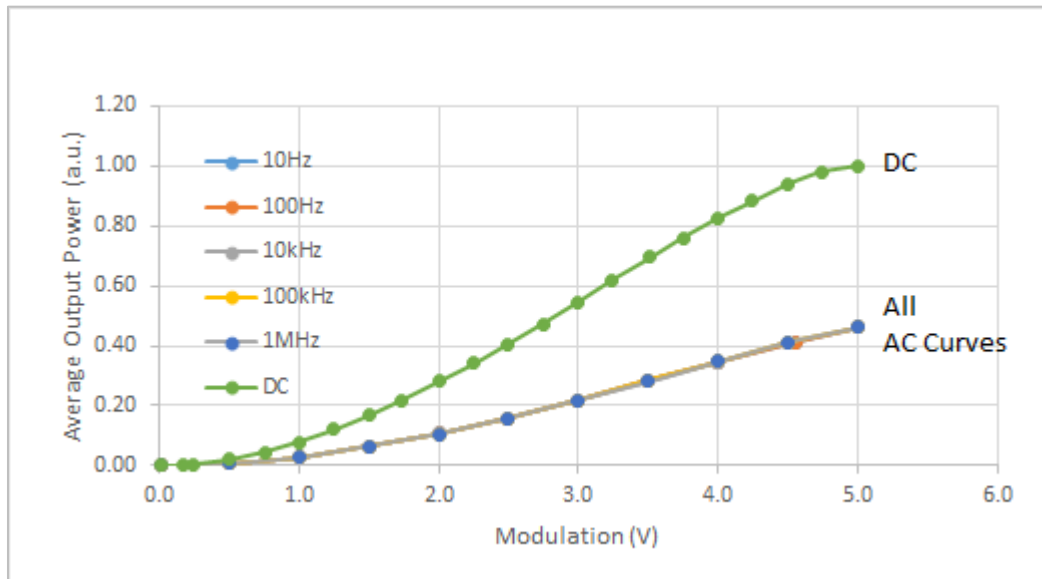

Fiber Coupled Acousto-Optic Modulator/Shifter Low Loss



(1.4dB, 400 to 2300nm, 80 MHz, all fiber types) (patent pending)

DATASHEET

Typical Stability (@ -20dBm with DC and 1kHz AC control. Fluctuation < 0.1dB)

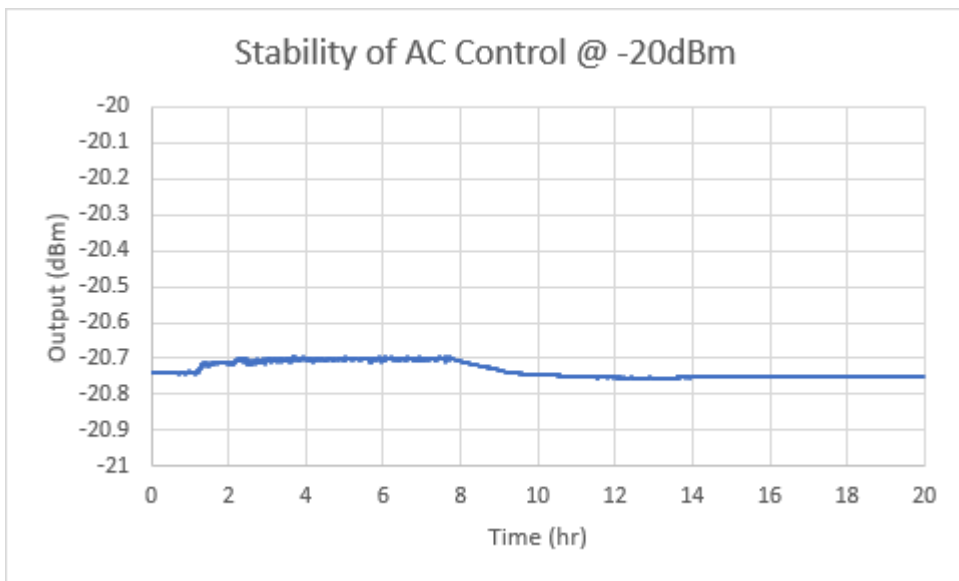
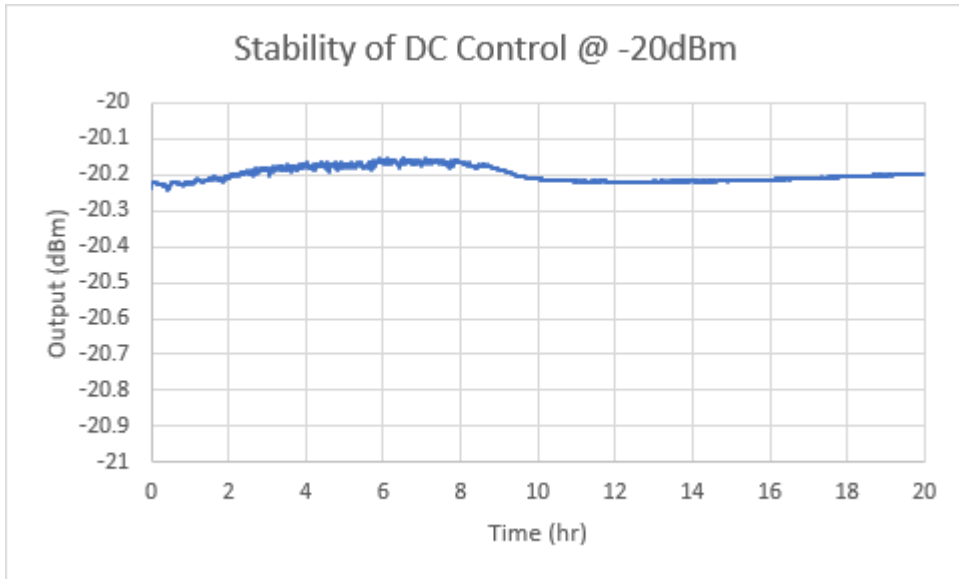

Fiber Coupled Acousto-Optic Modulator/Shifter Low Loss



(1.4dB, 400 to 2300nm, 80 MHz, all fiber types) (patent pending)

DATASHEET

Modulation Response (Top Optical/Bottom Electrical)

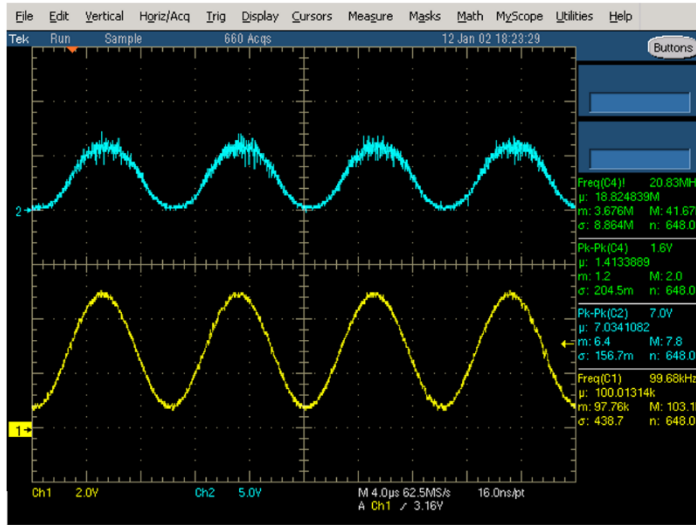

1 kHz

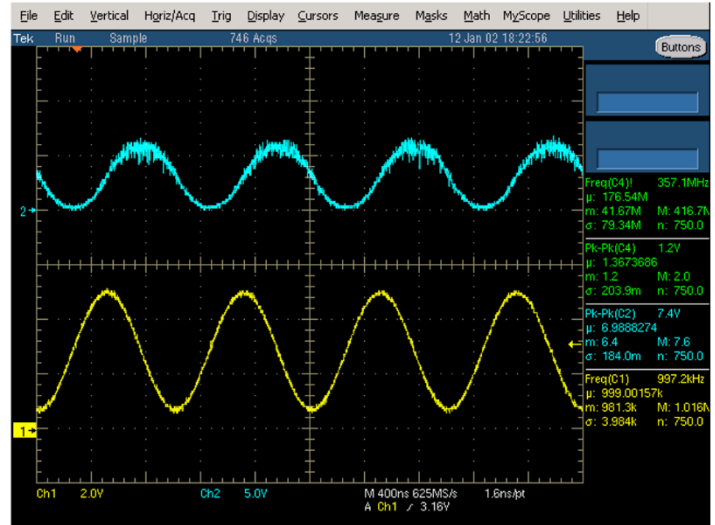

1 MHz

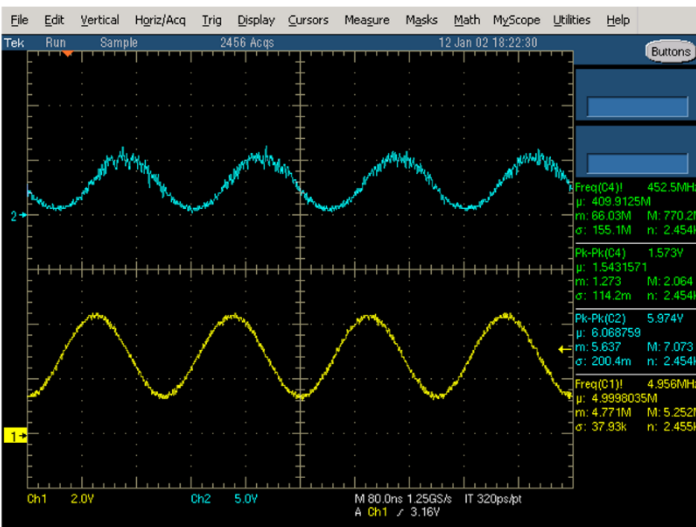

5 MHz

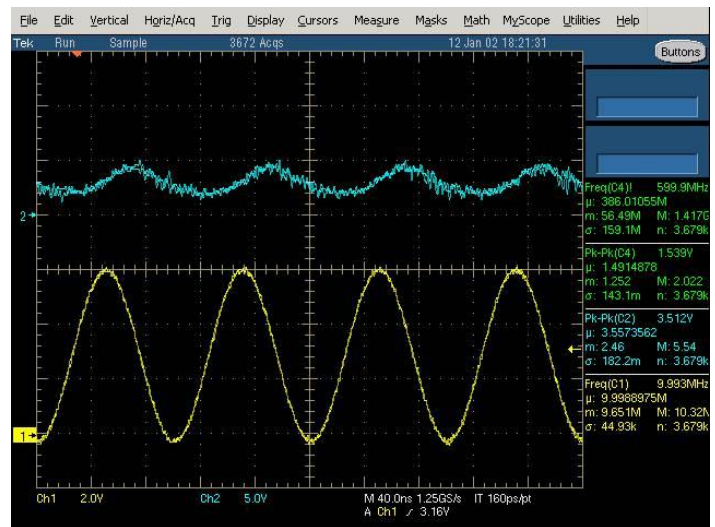

10 MHz

Fiber Coupled Acousto-Optic Modulator/Shifter Low Loss



(1.4dB, 400 to 2300nm, 80 MHz, all fiber types) (patent pending)

DATASHEET

Application Notes

Fiber Core Alignment

Note that the minimum attenuation for these devices depends on excellent core-to-core alignment when the connectors are mated. This is crucial for shorter wavelengths with smaller fiber core diameters that can increase the loss of many decibels above the specification if they are not perfectly aligned. Different vendors' connectors may not mate well with each other, especially for angled APC.

Fiber Cleanliness

Fibers with smaller core diameters ($<5 \mu\text{m}$) must be kept extremely clean, contamination at fiber-fiber interfaces, combined with the high optical power density, can lead to significant optical damage. This type of damage usually requires re-polishing or replacement of the connector.

Maximum Optical Input Power

Due to their small fiber core diameters for short wavelength and high photon energies, the damage thresholds for device is substantially reduced than the common 1550nm fiber. To avoid damage to the exposed fiber end faces and internal components, the optical input power should never exceed 20 mW for wavelengths shorter 650nm. We produce a special version to increase the how handling by expanding the core side at the fiber ends.