

O-Band Semiconductor Optical Amplifier, Non-linear



Description:

The PL-SOA-A-A81-W1310-SASA is a polarization-insensitive optical amplifier with advanced epitaxial wafer growth and opto-electronic packaging techniques that enable a high output saturation power, low noise figure, and large gain across a broad spectral bandwidth.

Features:

- Wide Optical Bandwidth
- High Output Power
- Low Polarization Sensitivity
- MQW or Bulk Structure

Application:

- Booster Amplifier
- Telecom and Datacom
- Loss Compensation

E/O Characteristics:

Electrical/Optical Characteristics(Tsub=25°C, CW bias unless stated otherwise)

tem #	Symbol	PL-SOA-A-A81-W1310-SASA		
		Min	Typical	Max
Operating Current	IOP	-	150 mA	200 mA
Operating Wavelength Range		1290 nm	-	1330 nm
Center Wavelength	λ_C	-	1310	-
Saturation Output Powerb (@ -3 dB)	PSAT	7dBm	10 dBm	-
Polarization extinction ratio	PER	15dB	20dB	
Small Signal Gain (Over O-Band @ Pin = -20 dBm)	G	15 dB	18 dB	-
Gain Flatness (Over O-Band @ Pin = -20 dBm)	ΔG	-	5 dB	7 dB
Gain Ripple (p-p) @ IOP, °C	δG	-	0.1 dB	0.5 dB
Polarization Dependent Gain	PDG	-	1.0 dB	1.8 dB
Noise Figure	NF	-	5 dB	7.0 dB
Forward Voltage	VF	-	1.6 V	1.8 V
Chip Length	-	-	1.5 mm	-
Waveguide Refractive Index	-	-	3.2	-
TEC Operation (Typical/Max @ TCASE = 25/70 °C)				
TEC Current	ITEC	-	0.23 A	1.5 A
TEC Voltage	VTEC	-	0.5 V	4.0 V
Thermistor Resistance	RTH	-	10 k Ω	-

Performance Plots:

ASE Spectrum

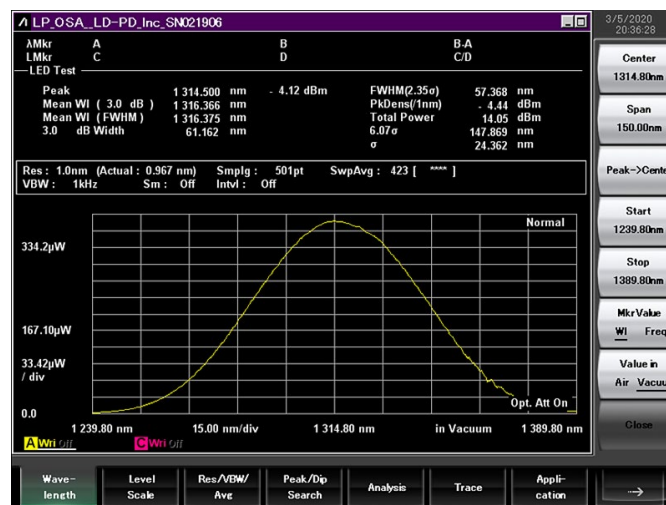

SOA Power amplification comparison(Pin = 0dBm, I = 200 mA)

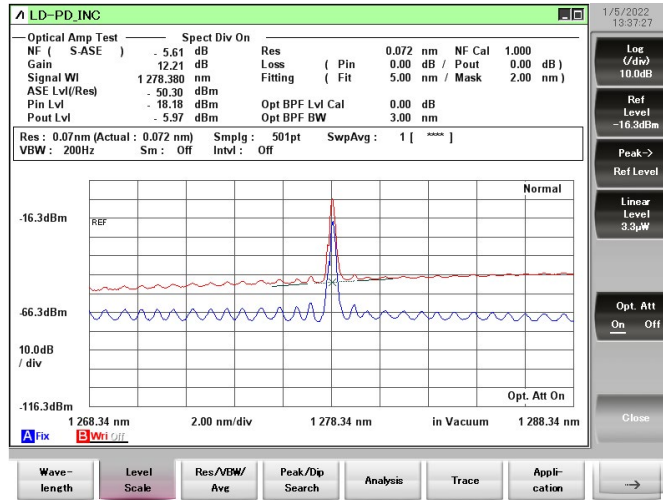

1278 nm (Pin = 0 dBm, I = 200mA)

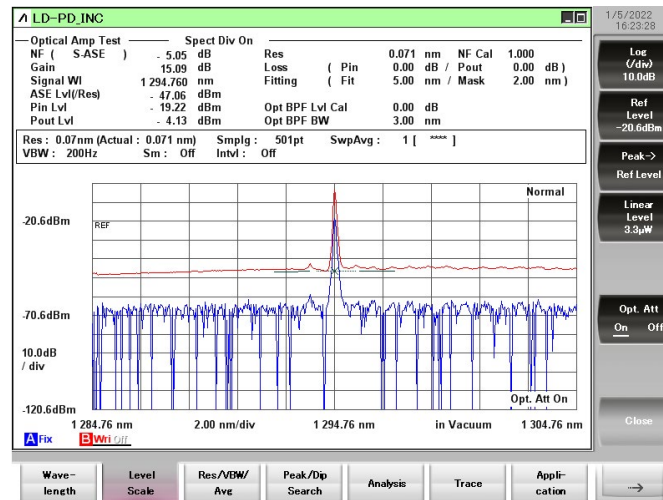

1294 nm (Pin = 0 dBm, I = 200mA)

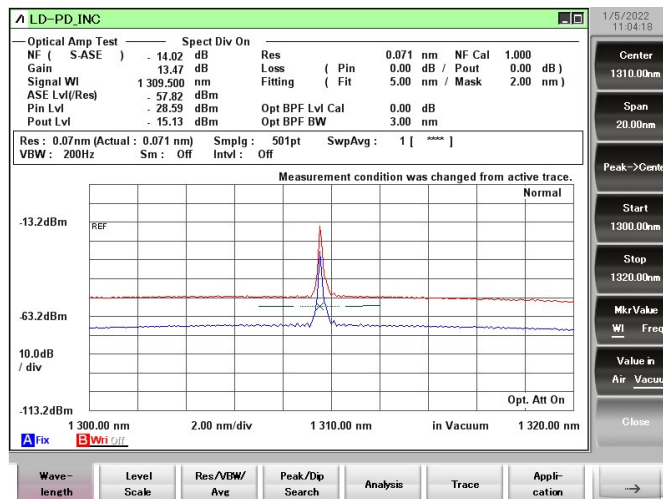

1310 nm (Pin = 0 dBm, I = 200mA)

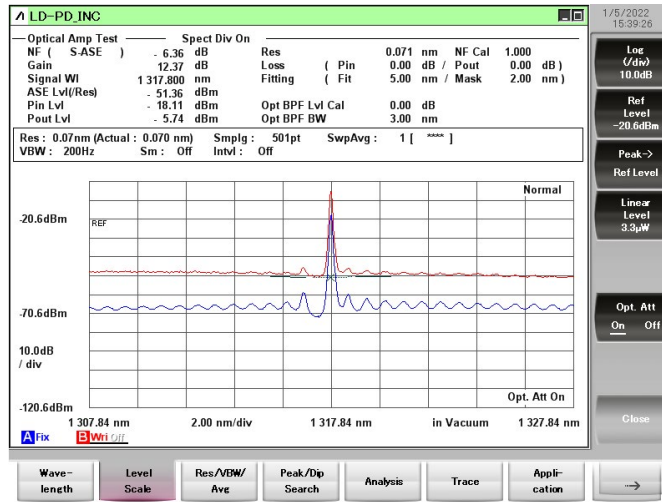

1317 nm (Pin = 0 dBm, I = 200mA)

Gain and NF Trend:

Gain and NF Trend

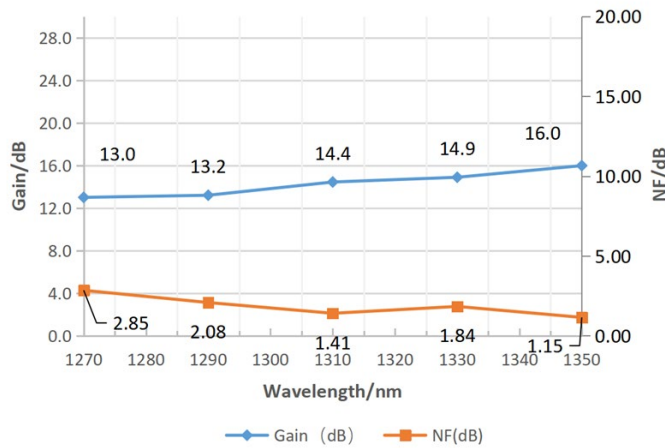

Psat Trend:

Psat Trend

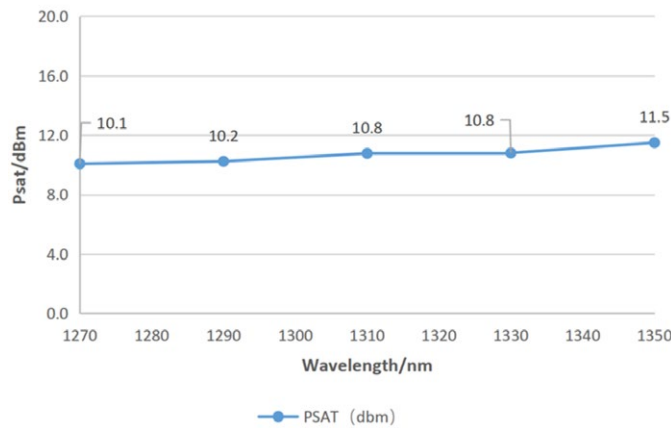

Dimensions and Pin definitions:

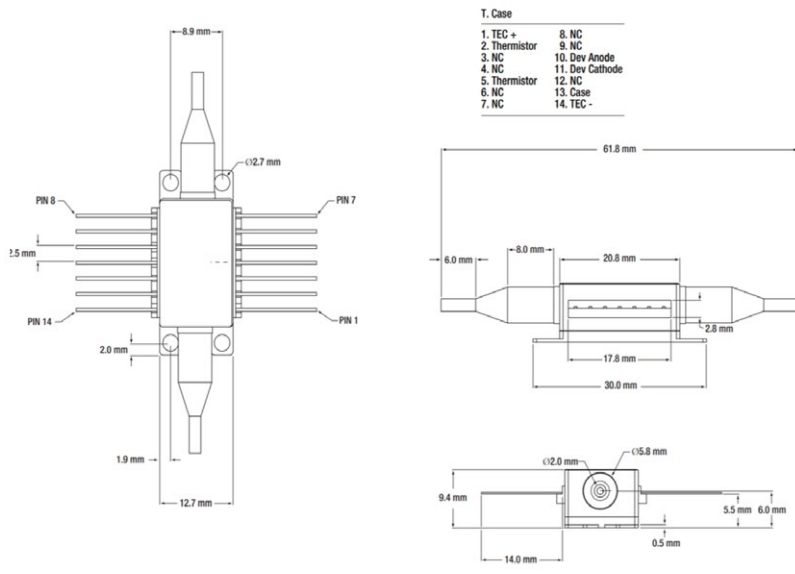

- T. Case**
- | | |
|---------------|-----------------|
| 1. TEC + | 8. NC |
| 2. Thermistor | 9. NC |
| 3. NC | 10. Dev Anode |
| 4. NC | 11. Dev Cathode |
| 5. Thermistor | 12. NC |
| 6. NC | 13. Case |
| 7. NC | 14. TEC - |

NO.	Function	NO.	Function
1	Thermoelectric Cooler (+)	8	N/C
2	Thermistor	9	N/C
3	NC	10	SOA Anode (+)
4	NC	11	SOA Cathode (-)
5	Thermistor	12	N/C
6	N/C	13	Case
7	N/C	14	Thermoelectric Cooler (-)

Ordering Info:

PL-SOA-☆-A8▽-W□□□□-XX

☆ : Small Signal Gain

A: 10dB

B: 15dB

▽: Bandwidth

1: 40-60nm

2: 30-40nm

□□□□: Wavelength

780: 680nm

850: 850nm

1310: 1310nm

1550: 1550nm

1600: 1600nm

XX: Fiber and Connector Type

SASA=(SMF-28E+ FC/APC)+(SMF-28E+ FC/APC)

SPSP=(SMF-28E+ FC/PC)+(SMF-28E+ FC/PC)

PAPA=(PM Fiber+ FC/APC)+(PM Fiber+ FC/APC)

PPPP=(PM Fiber+ FC/PC)+(PM Fiber+ FC/PC)

PAPA=(PM Fiber+ FC/APC)+(PM Fiber+ FC/APC)